



ADI 5850-J

# Emergency Shut Off System

## INSTALLATION AND OPERATING INSTRUCTIONS

**Carefully Read These Instructions Before Operating**

Controls Corporation of America  
1501 Harpers Road • Virginia Beach, VA 23454  
Telephone 1-800-225-0473 or 757-422-8330 • Fax 757-422-3125  
[www.concoa.com](http://www.concoa.com)



July 2024  
Revision J

## **SAFETY**



BASIC SAFETY PRECAUTIONS MUST BE FOLLOWED TO REDUCE THE RISK OF FIRE, ELECTRICAL SHOCK OR INJURY.

- While the ESO is dust and moisture resistant, it is NOT water-proof or completely sealed. It should be installed where it will not be subjected to rain or high concentrations of dust. Never pour or spray liquids directly onto the product.
- Install the ESO where the ambient temperature range is between 0° F and 140° F.
- THIS PRODUCT IS NOT INTENDED FOR USE IN EXPLOSIVE ENVIRONMENTS.
- DO NOT INSTALL THIS PRODUCT IN ANY HAZARDOUS ENVIRONMENT.
- If product appears damaged in any way, do not use and request service from CONCOA.

## **USER RESPONSIBILITY**

Service to this product should only be performed by CONCOA or an authorized CONCOA agent. Requests for service may be made through CONCOA CUSTOMER SERVICE at 1-800-225-0473. Written requests may be made using CONCOA's FAX number at 1-757-422-3125 or CONCOA's E-MAIL at [info@concoa.com](mailto:info@concoa.com)

CONCOA accepts no responsibility for damage or injury if this product is modified in any way.

CONCOA assumes/accepts no liability or responsibility for damage to individuals or equipment that may occur when using this product

# Index

Power Requirements .....	2
Alarm Output Relay Specifications .....	2
Mounting Requirements – Figure 1 .....	2
Figure 2: General Arrangement, External.....	3
Figure 3: General Arrangement, Internal.....	4
Figure 4: Hookup of Urethane Pneumatic Tubing.....	5
Figure 5: User Input Connections .....	6
Figure 6: Dry Contact Relay Output Connections .....	7
Figure 7: Standard Dry Contact Relay Outputs & Pneumatic Outputs Setup Diagrams.....	7
Figure 8: Dry Contact Relay Output Jumper Settings (N.C/N.O.) .....	8
Figure 9: Location of Real Time Clock Battery .....	8
Description of Product .....	9,10
Table 1: Inputs/Relays/Pneumatic Outputs Default States and Settings .....	9
Installation.....	11,12
Commissioning .....	13
Functionality Test .....	14
Setting Remote Alarm Outputs.....	15
Muting Audible Alarm.....	16
Resetting the System.....	16
Real Time Clock .....	16
Web Server - Status Page – Figure 10 .....	17
Web Server - View Settings Page – Figure 11 .....	18
Web Server - Change Settings Tab.....	18
Web Server Change Settings Tab: Configuration Page – Figure 12 .....	19
Web Server Change Settings Tab: Inputs Page – Figure 13.....	20
Web Server Change Settings Tab: Pneumatic Shut Off Page – Figure 14 .....	21
Web Server Change Settings Tab: Output Relays Page – Figure 15 .....	22
Web Server Change Settings Tab: E-mail Alerts Page – Figure 16 .....	23,24
Web Server - Networking Page – Figure 17.....	25,26
Web Server - Security Page – Figure 18.....	27
Warranty Information .....	28
CE Declaration of Conformity.....	29

# POWER REQUIREMENTS

Input Voltage: External Power Supply

Universal input voltage 90 ~264 VAC 50/60 Hz providing 12 VDC 1.5 A to circuit boards.

Power Consumption: 18 watts

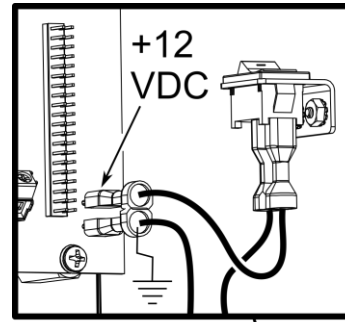

# ALARM OUTPUT RELAY SPECIFICATIONS:

Contacts: Normally Open/ Normally Closed (selectable) Dry Contact

Contact Rating: 24 volts DC @.5 amps Max.

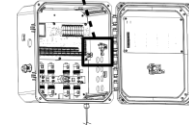

# MOUNTING REQUIREMENTS

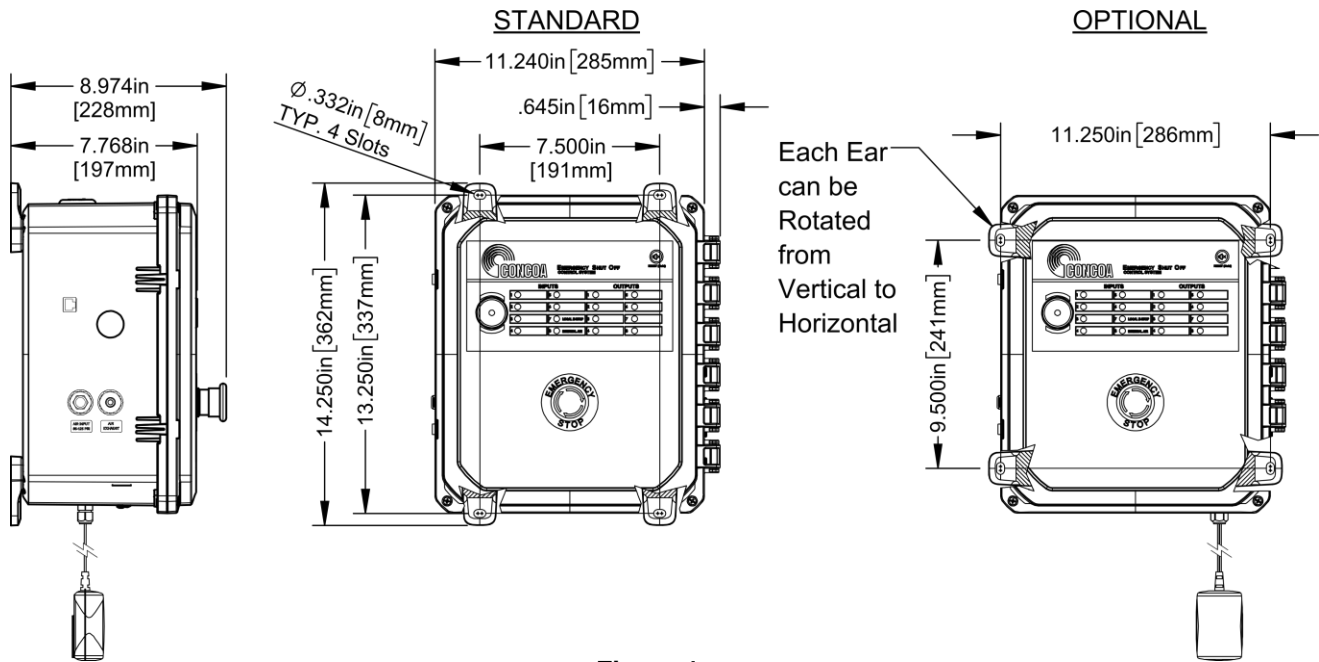

Figure 1

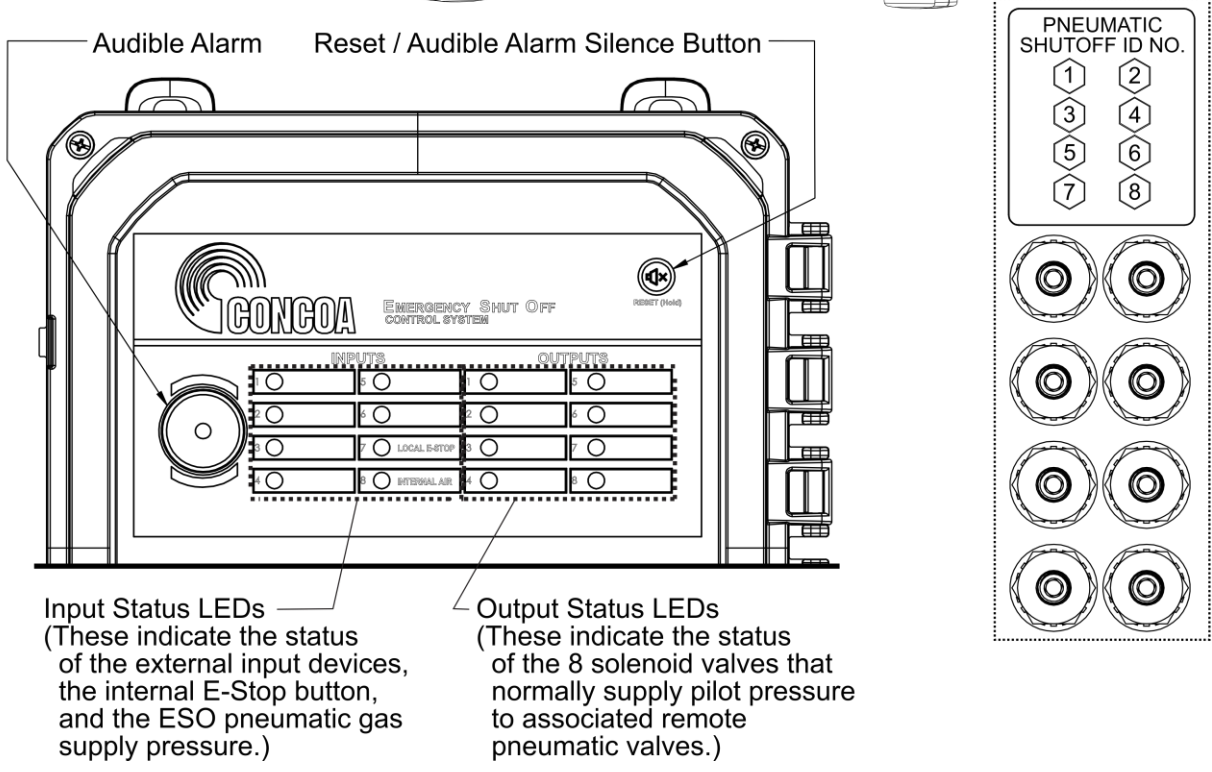
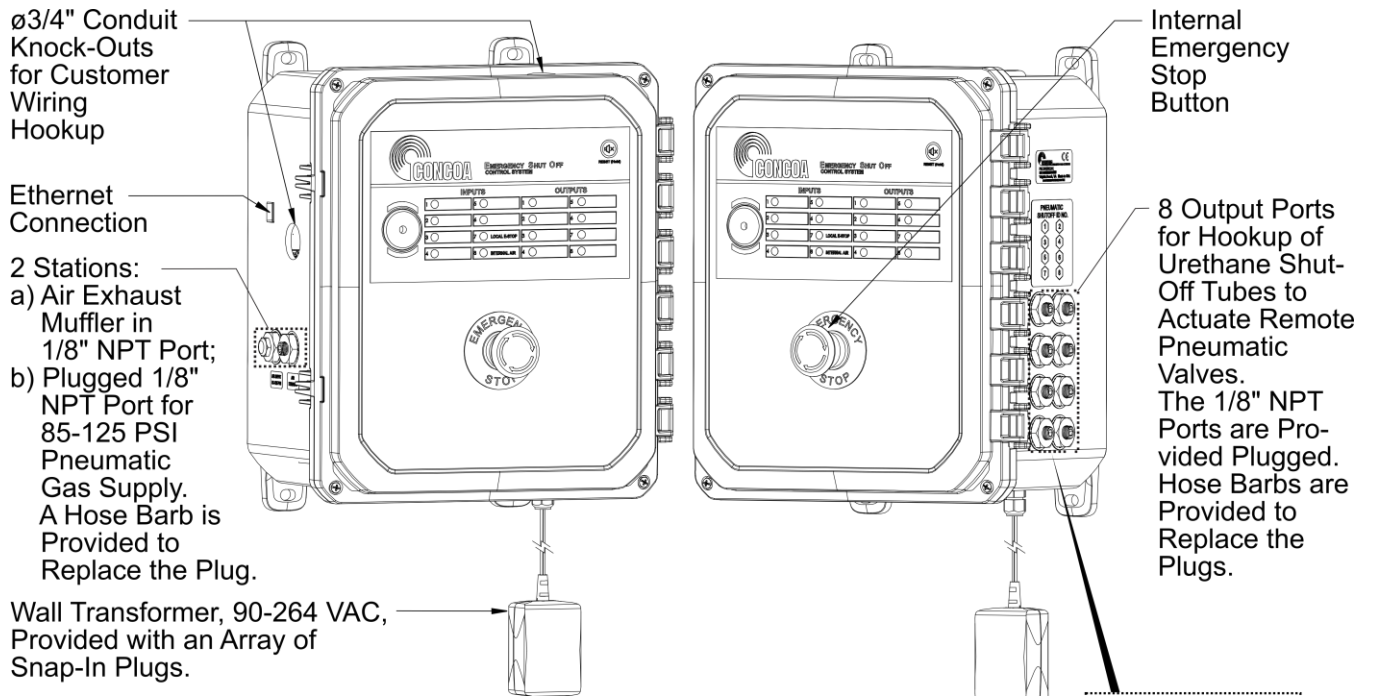

Figure 2

FRONT COVER OPEN

9 Upper Dry

Contact Relays:

These control the output to remote devices (e.g. remote alarms) from the 8 inputs and the master alarm (the master alarm is triggered if any of the other alarms are triggered).

Battery, Real Time Clock

Reset Button

Power Switch

Terminal Strip for Connecting User Input Devices (e.g., E-Stop Buttons) and Output Devices (e.g., Remote Alarms).

8 Solenoid Valves that Actuate Remote Pneumatic Shutoff Valves Connected to the Indicated Output Port (#1,#2, ... #8).

Pressure Switch: Monitors the Pneumatic Gas Supply Pressure

9 Lower Dry

Contact Relays: Not Used

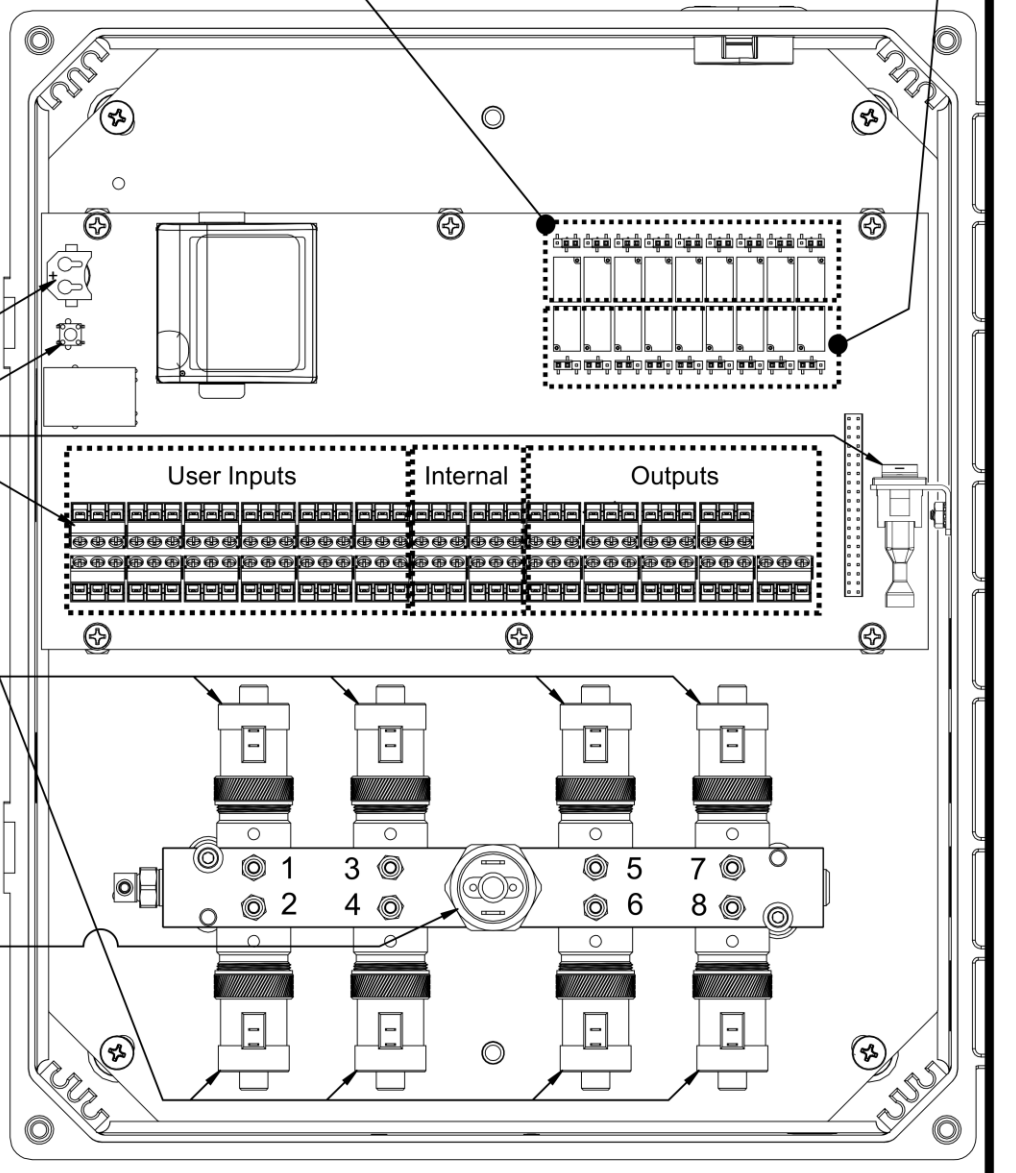
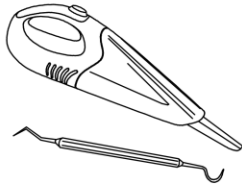
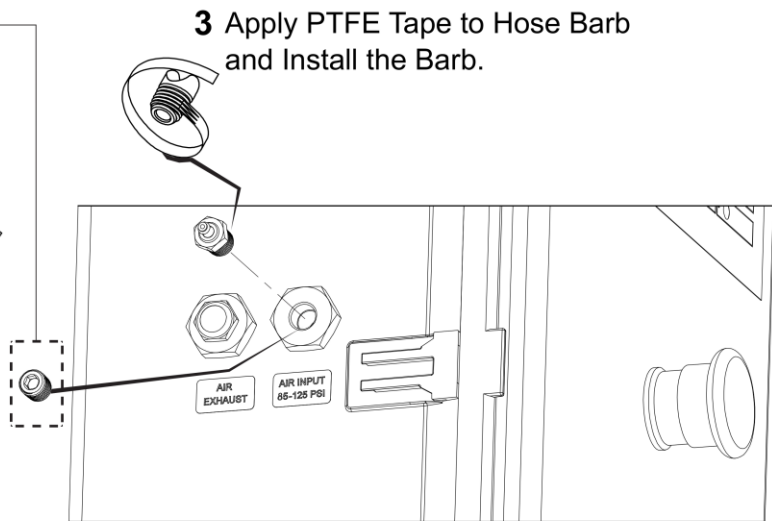

Figure 3

**1** Remove and Discard Plug.



**2** Clean Old PTFE Tape Out of Port.



**3** Apply PTFE Tape to Hose Barb and Install the Barb.

**4** Press a Urethane Pneumatic Gas Supply Tube onto the Barb.

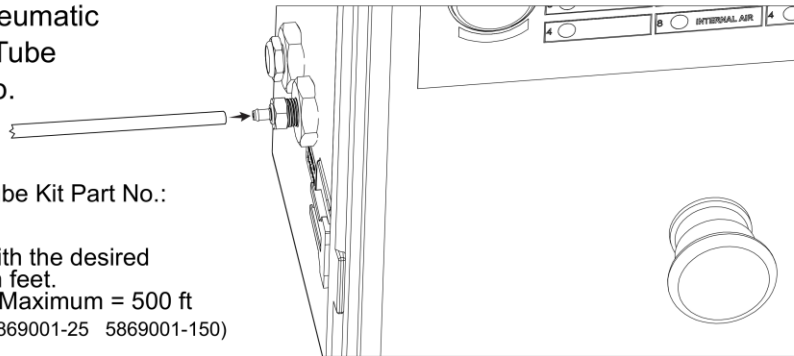

CONCOA Gas Tube Kit Part No.:  
5869001-XXX  
Replace "XXX" with the desired length of tubing in feet.  
Minimum = 25 ft, Maximum = 500 ft  
(Example part nos: 5869001-25 5869001-150)

## Typical Each Station to be Utilized:

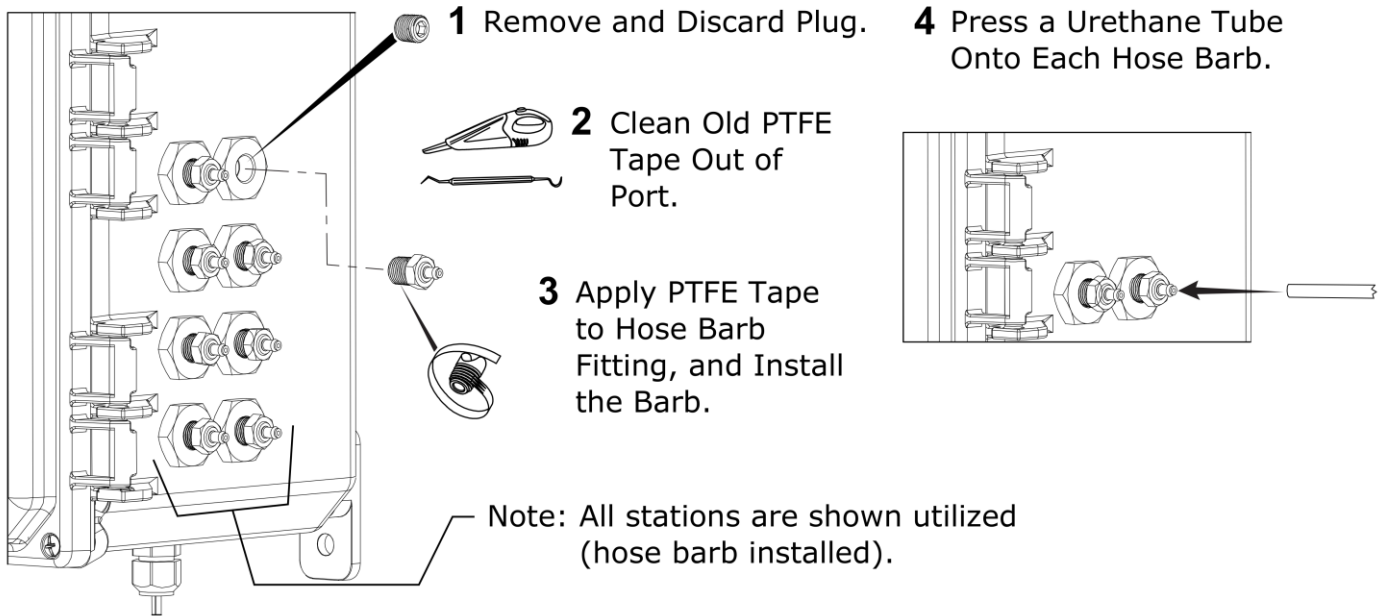

**Figure 4**

# Typical User Inputs

(E-Stop Buttons are Shown as an Example. Other Devices [e.g., LEL Detectors] May Be Connected.)

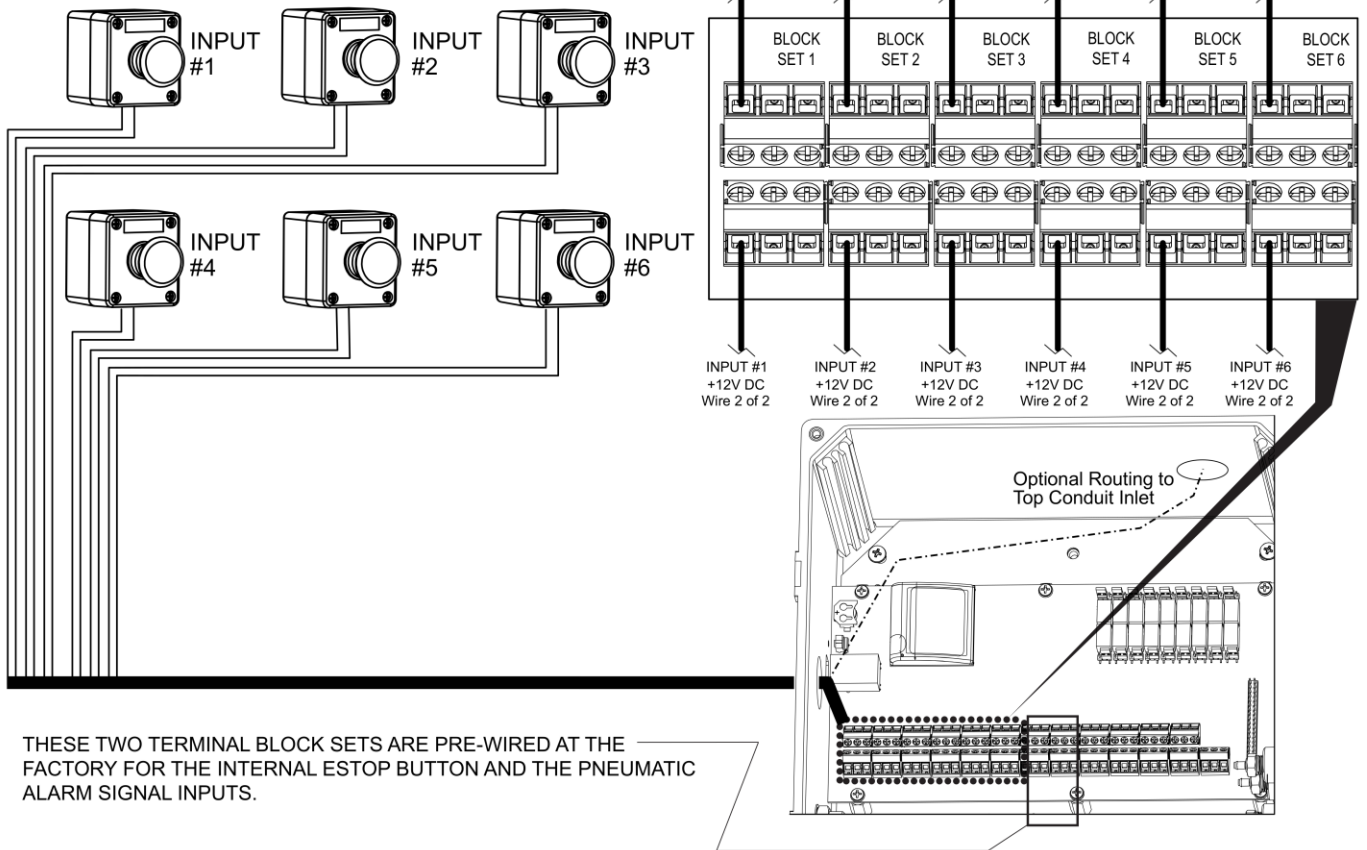
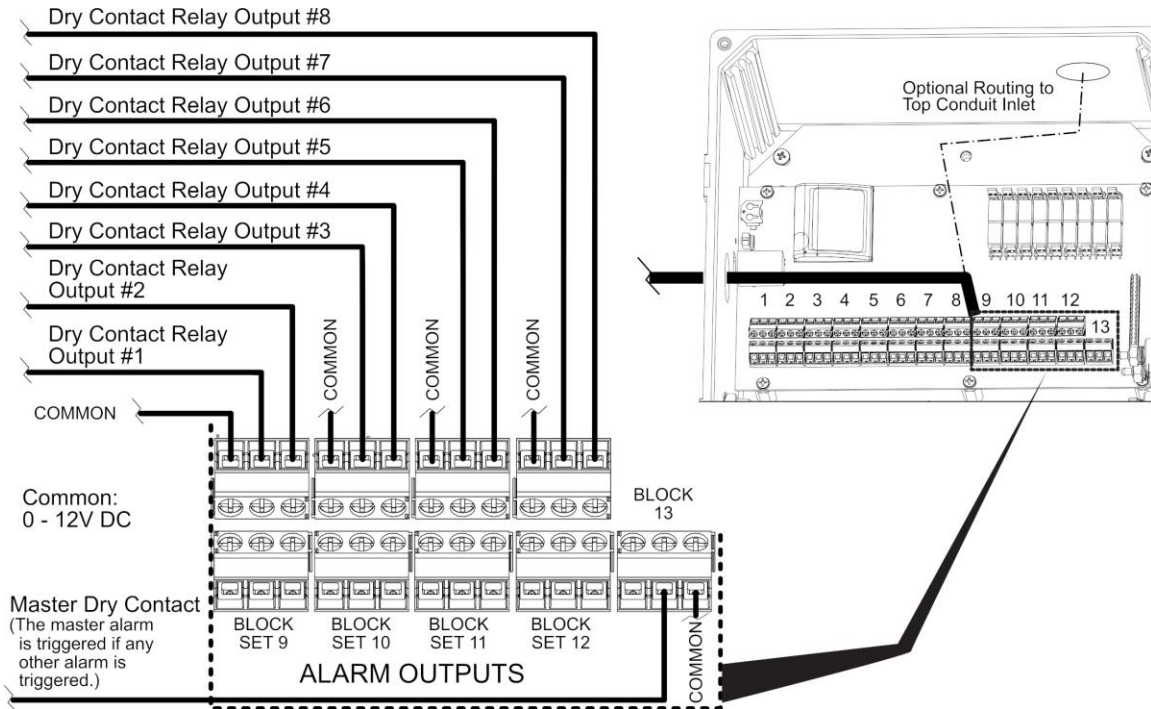
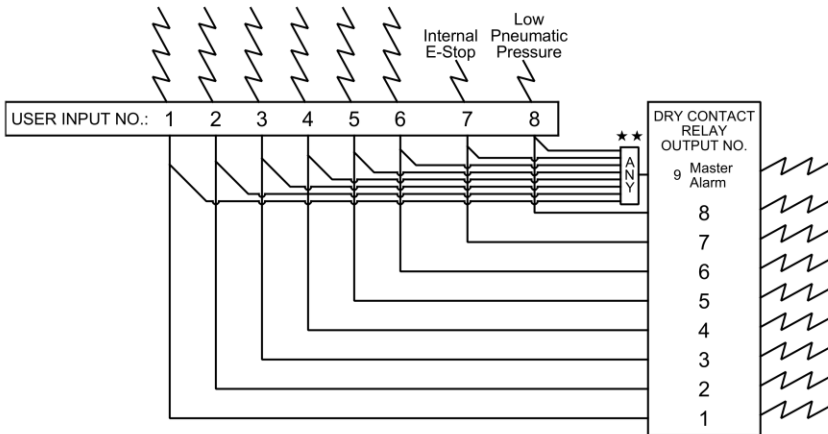

Figure 5





**\* STANDARD DRY CONTACT RELAY OUTPUTS SETUP**



\* Except for the master alarm, all connections for both the pneumatic outputs and for the dry contact relay outputs are fully configurable via the web interface software. This includes the ability to link multiple inputs to a single output and the ability to link a single input to multiple outputs. There is no requirement for the output number to match the input number.

\* \* Except for the master alarm dry contact relay output (which is permanently set to ANY), each dry contact relay output can be set via the web interface software to one of two settings:  
 a) send signal if ANY of the linked inputs are in the alarm condition;  
 b) send signal if ALL of the linked inputs are in the alarm condition.

**\* STANDARD PNEUMATIC OUTPUTS SETUP**

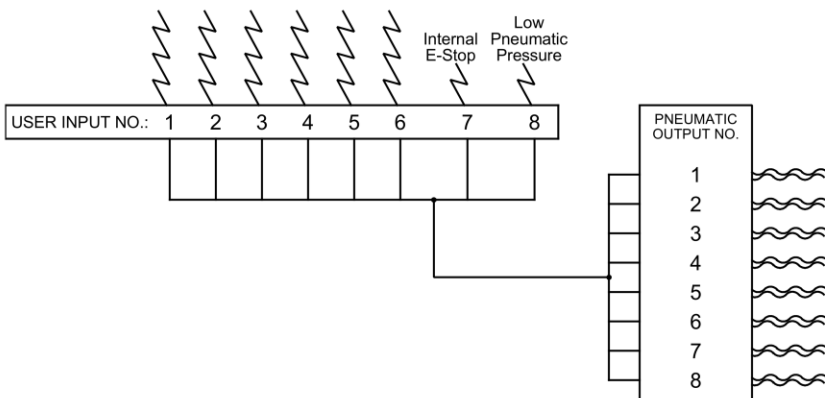

**Figure 7**

**STANDARD CONFIGURATION,  
NORMALLY CLOSED:**

THE 2 PINS FARTHEST FROM  
THE RELAY DOT MARK ARE  
SHORTED

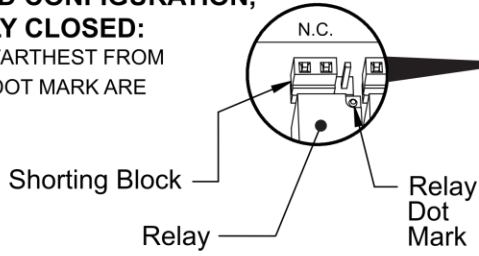

**DRY CONTACT RELAY OUTPUTS**

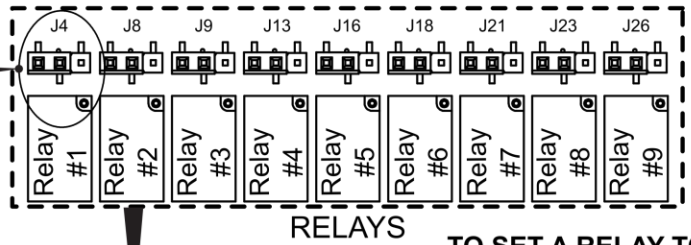

**TO SET A RELAY TO  
NORMALLY OPEN**

MOVE THE SHORTING  
BLOCK TO THE PINS  
ON OPPOSITE SIDE  
(NEAREST TO DOT).

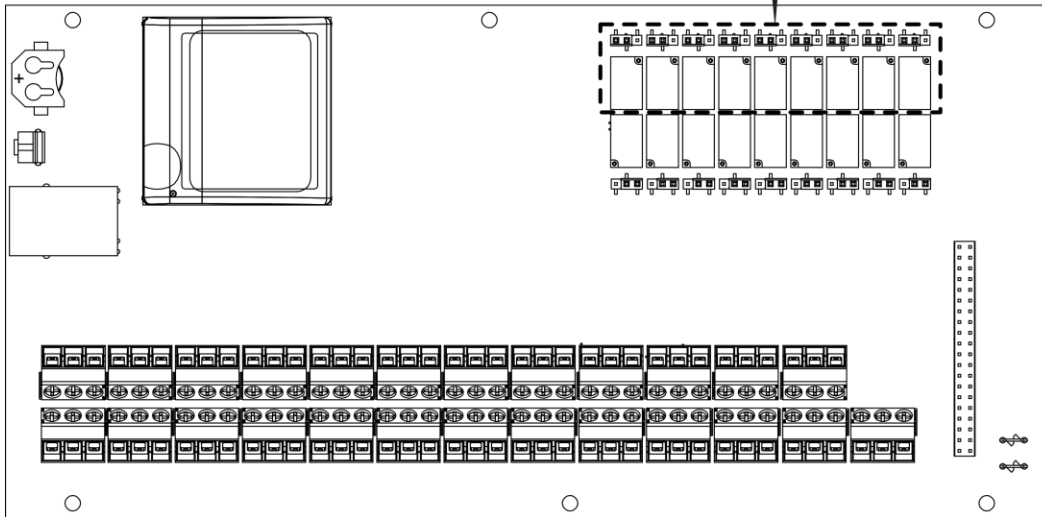
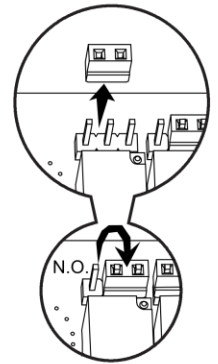

Figure 8

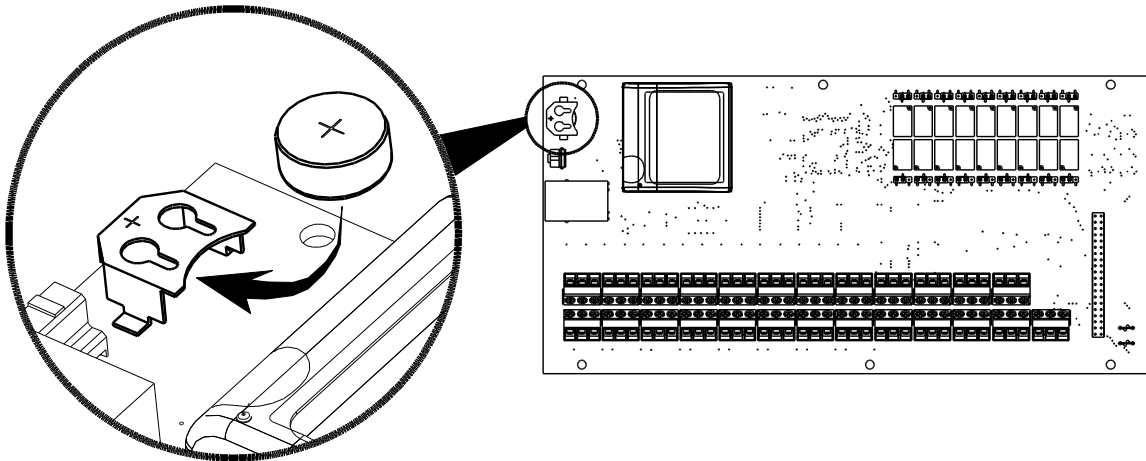

Figure 9

# DESCRIPTION OF PRODUCT

The ESO system is designed to monitor 6 user Input Signals and 2 internal input signals (8 total). The 2 internal input signals monitor a local E-Stop button on the outside of the ESO system and an internal pneumatic alarm pressure switch. LEDs indicate the status of each of the inputs on the front panel of the ESO system.

When one of the inputs is triggered, the ESO system will depressurize the configured Pneumatic Valve Outputs and shut-off gas flow on pneumatic diaphragm valves. The ESO can control 8 different Pneumatic Valve Outputs from the bulkheads on the right side of the system. Pneumatic pressure is supplied from an outside source on the left side of the ESO system.

When one of the inputs is triggered, the ESO system can also be configured to provide a Dry Contact Relay Output to an external alarm or other system that takes Dry Contact inputs. The ESO can control 8 different Dry Contact Relay Output signals. The system also comes with a Master Dry Contact Relay that will signal when any of the other Dry Contacts Relays are triggered. These Dry Contact Relay Outputs can be configured as normally open or normally closed using jumpers on the main control board.

The Input Signals, Pneumatic Valve Outputs, and the Dry Contact Relay Output functions are controlled through an Ethernet Web-Server interface. The default settings for each are detailed in Table 1 below:

No.	Description	Default State <small>(Units sold as a built-in component of a gas cabinet are provided preconfigured and will differ from the data below)</small>	To Enable/ Disable	To Change Normally Open/Closed	To Configure Trigger Conditions
<b>Input Signals - Figure 5 &amp; Figure 13</b>					
1	User Input 1	Disabled / Normally Closed	Webserver	Webserver	n/a
2	User Input 2	Disabled / Normally Closed	Webserver	Webserver	n/a
3	User Input 3	Disabled / Normally Closed	Webserver	Webserver	n/a
4	User Input 4	Disabled / Normally Closed	Webserver	Webserver	n/a
5	User Input 5	Disabled / Normally Closed	Webserver	Webserver	n/a
6	User Input 6	Disabled / Normally Closed	Webserver	Webserver	n/a
7	Internal E-Stop Button	Enabled / Normally Closed	n/a	n/a	n/a
8	Internal Pneumatic Alarm	Enabled / Normally Closed	n/a	n/a	n/a
<b>Dry Contact Relay Outputs - Figure 6, Figure 8, Figure 15</b>					
1	Dry Contact Relay 1	Enabled for ANY event that happens on Input 1	Webserver	Jumper J4	Webserver
2	Dry Contact Relay 2	Enabled for ANY event that happens on Input 2	Webserver	Jumper J8	Webserver
3	Dry Contact Relay 3	Enabled for ANY event that happens on Input 3	Webserver	Jumper J9	Webserver
4	Dry Contact Relay 4	Enabled for ANY event that happens on Input 4	Webserver	Jumper J13	Webserver
5	Dry Contact Relay 5	Enabled for ANY event that happens on Input 5	Webserver	Jumper J16	Webserver
6	Dry Contact Relay 6	Enabled for ANY event that happens on Input 6	Webserver	Jumper J18	Webserver
7	Dry Contact Relay 7	Enabled for ANY event that happens on Input 7	Webserver	Jumper J21	Webserver
8	Dry Contact Relay 8	Enabled for ANY event that happens on Input 8	Webserver	Jumper J23	Webserver
9	Dry Contact Relay Master	Enabled for ANY event that happens on ANY input	Webserver	Jumper J26	Webserver
<b>Pneumatic Shutoff Output (solenoid valve controlled) - to output bulkheads - Figure 4 &amp; Figure 14</b>					
1	Pneumatic Shutoff 1	Will Shutoff when ANY of the 8 inputs are triggered	Webserver	Webserver	Webserver
2	Pneumatic Shutoff 2	Will Shutoff when ANY of the 8 inputs are triggered	Webserver	Webserver	Webserver
3	Pneumatic Shutoff 3	Will Shutoff when ANY of the 8 inputs are triggered	Webserver	Webserver	Webserver
4	Pneumatic Shutoff 4	Will Shutoff when ANY of the 8 inputs are triggered	Webserver	Webserver	Webserver
5	Pneumatic Shutoff 5	Will Shutoff when ANY of the 8 inputs are triggered	Webserver	Webserver	Webserver
6	Pneumatic Shutoff 6	Will Shutoff when ANY of the 8 inputs are triggered	Webserver	Webserver	Webserver
7	Pneumatic Shutoff 7	Will Shutoff when ANY of the 8 inputs are triggered	Webserver	Webserver	Webserver
8	Pneumatic Shutoff 8	Will Shutoff when ANY of the 8 inputs are triggered	Webserver	Webserver	Webserver

Table 1

Figure 2 shows the general arrangement of the system enclosure, the front graphic with LEDs and reset button. It shows the location of the various inputs, outputs and indicators for the ESO. The ESO includes a universal power supply (see page 2 for specifications).

Figure 3 shows the general internal arrangement of the system, the circuit board and the internal power switch. It also shows the Dry Contact Relay placement, the Customer Input terminal strips, the internal terminal strips, the Dry Contact Relay Output terminal strips and the reset button. This figure also shows the Pneumatic Valves that control the outlet bulkhead fittings on the side of the ESO – used to control Pneumatic Valves.

# INSTALLATION

## Mounting, Input Signals, Dry Contact Relay Output, Pneumatic Input and Pneumatic Output

### Mounting

1. Mount the ESO system to a wall, an ESO bracket or other structure (see figure 1).
2. With no power to the unit, remove the 4 corner screws, and open the ESO system (hinged door).
3. Ensure that a button cell battery is installed the 1.5V in the battery holder in the upper left corner of the main control board (see figure 9 and REAL TIME CLOCK section on page 16).  
For setting the time and date, see WEB SERVER CHANGE SETTINGS TAB: CONFIGURATION PAGE, page 19, figure 12.

### Input Signals

4. Install user required Input Signal devices in their designated locations.  
Examples of user input signal devices:  
E-Stop button, LEL Gas Detector, Excess Flow Switch, Oxygen Monitor, etc.  
These devices should operate with +12V DC power as a Dry Contact Relay Closure.
5. Run wires from the user Input Signal devices to the ESO system using 14-26 gauge wire (AWG). These wires can be run through conduit to the conduit holes (designed for a 3/4" conduit connector) on the ESO enclosure. The max wire length should be limited to 1500 ft max for each input.
6. Wire the user Input Signal devices to the ESO system to the main control board user Input Terminal Strips shown in figure 3 & figure 5. The ESO provides +12V signal voltage to the user Input Signal devices.
7. Space has been provided next to each of the front panel LEDs for the user to label or mark the name of each input so that they can be readily identified when a trigger event is detected. Mark as necessary.

### Dry Contact Relay Output

8. Install user required Dry Contact Relay Output devices in their designated locations, or locate them if already installed.  
Examples of user Dry Contact Relay Output devices include:  
Remote Alarms, Building Management Systems, etc.  
These devices must supply 0-24V DC to the ESO system and must operate as Dry Contact Relay devices.
9. Run wires from the user Dry Contact Relay Output devices to the ESO system using 14-26 gauge wire (AWG). These wires can be run through conduit to the conduit holes (designed for a 3/4" conduit connector) on the ESO enclosure. The max wire length should be limited to 1500 ft max for each output.
10. Wire the user Dry Contact Relay Output devices to the ESO system to the main control board Dry Contact Relay Terminal Strips shown in figure 3 & figure 6. The ESO provides +12V signal voltage to the user Input Signal devices.
11. Set the Dry Contact Relay Output to customer required Normally Open and/or Normally Closed using Jumpers outlined in Tables 1 and 2, and Figures 3 and 8.

### **Pneumatic Input**

12. On the left side of the enclosure (see figure 4), replace the 1/8" NPT pipe plug in the "Air Input" port with one of the provided hose barbs. Use  $\varnothing$ 1/8" ID urethane tubing (available from CONCOA – see figure 4) to connect to a pneumatic gas input at a pressure of 85-125 psi of dry air or other inert gas.

**NOTE: CONCOA strongly recommends supplying pneumatic pressure with an in-line check valve from a continuous source (such as a house compressed air or dry nitrogen line). Due to the quantity and nature of internal connections, the unit may leak up to 25 cubic feet of pneumatic gas per year. If supplying pneumatic gas from a single cylinder, consider monitoring the outlet pressure of the cylinder regulator to prevent system failure outside the required pressure range. Under no circumstances should any process gas in a flammable gas installation (including inert purge gases) be used as a source of pneumatic supply for the device.**

### **Pneumatic Output**

13. On the output fittings on the right side of the enclosure (see figure 4), for each pneumatic output that will be utilized, replace the 1/8" NPT pipe plug(s) with one of the provided hose barbs and connect a  $\varnothing$ 1/8" ID urethane tube between the ESO and the associated pneumatically operated shut-off valve. Up to 8 independently controlled shut-off valve systems can be attached to the ESO system.
14. Ensure that all unused output ports remain plugged and all open ports have been fitted with hose barbs and tubing.
15. Space has been provided next to each of the front panel LEDs for the user to label or mark the name of each pneumatic output so that they can be readily identified when a trigger event is detected. Mark as necessary.

### **Webserver**

16. The ESO is equipped with an integral web server as a means for remote monitoring and configuration of the system. Connection to the webserver is achieved through an RJ45 connector located on the left hand side of the unit (see figure 2). Refer to the ESO Webserver Configuration Instructions for connection instructions, including factory default network and security settings. The internal reset button is used to restore factory network settings if necessary.
17. Connect the RJ45 connector into your network or use a crossover cable to connect to a laptop in order to configure the ESO settings as detailed in this document and table 1 above.

# COMMISSIONING

## **Pneumatic Input**

1. Pressurize the pneumatic gas input to 85-125 psi of dry air or other inert gas.
2. Leak check pneumatic gas input from its source to the side of ESO, to include the hose barb pipe thread and both ends of the urethane tubing.

## **Powering Up for the First Time**

3. Ensure that all wiring is secured to the terminal strips and meets the wiring diagrams in this manual.
4. Plug in the ESO directly into the wall using the Universal Power Supply provided.
5. Turn on the power switch inside the ESO – see figure 3.
6. If audible alarm sounds, it can be silenced by pressing the alarm silence button on the outside of the ESO door.
7. Close the ESO enclosure, and tighten the 4 corner screws on the door.

## **Webserver Configuration**

8. Refer to the section titled Webserver Configuration on page 19 of this manual.
9. Configure all necessary user Input Signals, user Dry Contact Relay Outputs, user Pneumatic Shut-offs, e-mail alerts and settings, date, time, network settings & security settings.

## **Initial Test**

10. Press the alarm silence button and hold for 5 seconds – this serves as a system RESET.
11. If everything is configured correctly, all configured input LEDs will be green and all configured output LEDs will be green. If not, the system needs to be reconfigured.
12. If all LEDs are green, leak check the pneumatic output side of the ESO from the 1/8" NPT port all the way to each of the installed Pneumatic Diaphragm Valves.
13. Pressurize the systems attached to the ESO to ensure gas flow through each of the Pneumatic Diaphragm Valves is successful. Start a small flow on each of the connected devices - then continue to the next step.

## FUNCTIONALITY TEST

1. Press the local e-stop button on the front of the ESO – the following should occur:
  - a. The ESO will provide an audible indication of a trigger event – silence this with the alarm silence button.
  - b. The ESO will depressurize the configured Pneumatic Diaphragm Valves and gas flow through each of the connected Pneumatic Diaphragm Valves should cease to flow.
  - c. The LED indicating that the local e-stop button was pressed should now be red.
  - d. The LED of the configured Pneumatic Output valve should also be red.
  - e. If all of these conditions are not met, then the unit needs to be reconfigured.
  - f. Do NOT continue until these are met.
2. Twist and release the local e-stop button on the front of the ESO – the following should occur:
  - a. The LED indicating that the local e-stop button was pressed should change from red to blinking green.
  - b. The blinking green indicator shows that this was the input that stopped all flow.
  - c. The LED of the configured Pneumatic Output valve will still be red.
  - d. If all of these conditions are not met, then the unit needs to be reconfigured.
  - e. Do NOT continue until these are met.
3. Press the alarm silence button and hold for 5 seconds – this serves as a system RESET – the following should occur:
  - a. The LED indicating that the local e-stop button was pressed should change from blinking green to solid green.
  - b. The LED indicating that the configured Pneumatic Output valve should turn from red to green.
  - c. Gas should resume flowing from the Pneumatic Diaphragm Valve attached to the Pneumatic Output.
  - d. If all of these conditions are not met, then the unit needs to be reconfigured.
  - e. Do NOT continue until these are met.
4. Functionality of EVERY input should be checked to ensure proper operation by triggering each of the inputs as appropriate and checking for the expected outcome as detailed for the e-stop button steps 1 - 3 above.

Once all installation, commissioning, and testing is completed successfully, the ESO is ready for operation.



## SETTING REMOTE ALARM OUTPUTS

The output signals from the ESO are brought out of the alarm through relay contacts. These contacts are set as Normally Closed (N.C.) FACTORY DEFAULT. The relay contacts can be reconfigured as Normally Open (N.O.). To change the relay configuration, perform the following steps:

1. Unplug the alarm from AC power.
2. Open the unit by loosening the 4 screws located on the front of the enclosure.
3. Figure 8 shows the location of the jumpers on the circuit board for setting the contacts.
4. Using Table 1 and Figure 8, set the jumpers to the desired contact arrangement.
5. Reattach the two sections of the enclosure with the screws previously removed.
6. Make the necessary connections to the alarm and plug the alarm cable into the alarm connector on the bottom of the cabinet.
7. Plug the alarm back into the AC power.

<b>Jumper</b>	<b>N.C. / N.O. Setting for:</b>
J4	Dry Contact Output #1
J8	Dry Contact Output #2
J9	Dry Contact Output #3
J13	Dry Contact Output #4
J16	Dry Contact Output #5
J18	Dry Contact Output #6
J21	Dry Contact Output #7
J23	Dry Contact Output #8
J26	Master Alarm

**Table 2**

## MUTING AUDIBLE ALARM

Temporarily silence the alarm by pressing the alarm silence button on the top right hand side of the front graphic (see figure 2). In this mode, the audible alarm will automatically sound on the next asserted alarm.

## RESETTING THE SYSTEM

By default, the ESO system shuts off all the pneumatically controlled devices connected to the pneumatic output ports when either the local estop button is pressed or when the pneumatic gas pressure becomes too low. Customer-installed and configured devices may shut off one or more pneumatic outputs when an alarm condition occurs. After the alarms have been cleared, the ESO system will keep the disabled pneumatic valves disabled until a manual reset has been performed. A manual reset is initiated by pressing and holding the “Reset (Hold)” button for 5 seconds. If all the input alarms are clear, all disabled pneumatic valves will re-enable and return their gas systems to service.

### **Note for AC Power Outages & Disconnections:**

When a power outage or power disconnection to the ESO occurs, all pneumatic valves controlled by the ESO will shut off. To turn them back on and return connected systems to normal service after power is restored (provided no other alarm conditions exist):

Press and Hold the “Reset (Hold)” button on the front graphic for 5 seconds.

## REAL TIME CLOCK

The ESO has a battery backed real-time clock (RTC) that requires a button cell battery with a nominal voltage of 1.55 V (see figure 3 and figure 9 – a silver oxide 357, SR44 or equivalent battery is shipped installed on the circuit board). Using typical current capacity, the RTC is expected to have 120,000 backup hours (over 13 years). The battery is mounted inside a holder attached to the main circuit board to allow battery replacement or removal.

To set the date and time, see section WEB SERVER CHANGE SETTINGS TAB: CONFIGURATION PAGE, page 19, figure 12.

# WEB SERVER - STATUS PAGE

The ESO webserver Status screen is essentially a copy of the front graphic on the ESO unit. Each of the front panel LED's and labels are represented and colored RED or GREEN based on alarm status. Also a copy of the last 20 events in the onboard event log are displayed at the bottom of the screen. An Export Log button at the bottom also allows for exporting of the entire event log in csv format.

The system event log has a maximum size of 500 Kb. When the event log reaches 90% of the maximum size, a warning email will be sent to all enabled email recipients. When the event log reaches capacity, no new items will be added to the log. New events will continue to be displayed in the "Recent Events" portion of the Status page, and every subsequent email sent from the ESO will have "(Event Log full)" appended to the subject line.

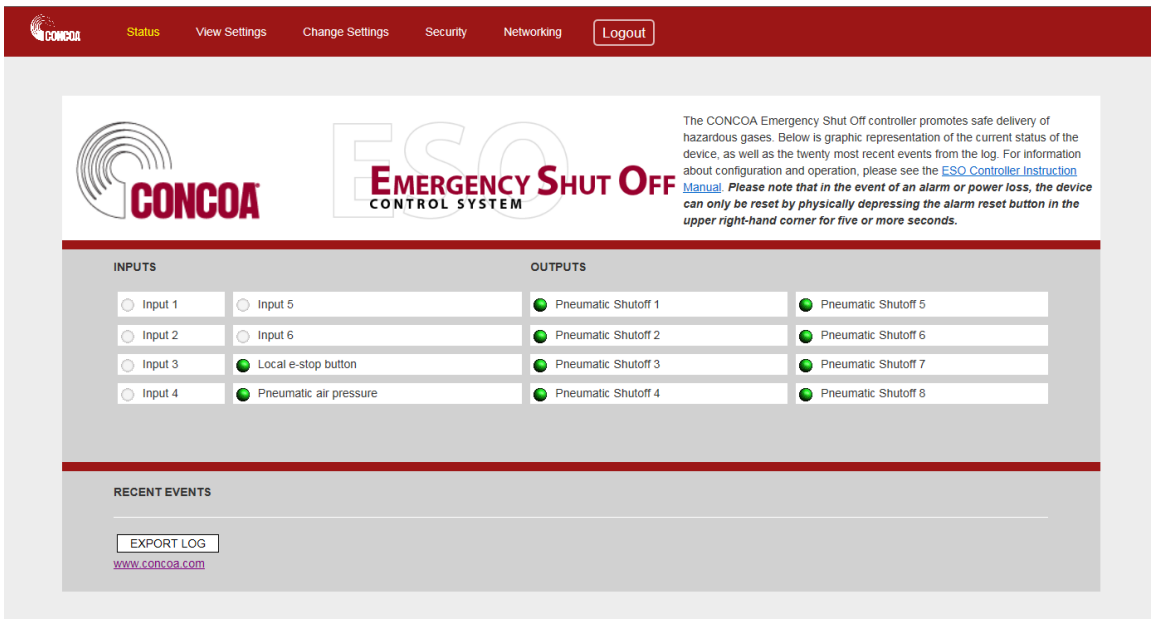

Figure 10

## WEB SERVER - VIEW SETTINGS PAGE

The ESO webserver View Settings screen displays several system parameters: webserver software version; firmware version; and alarm silence status. An EXPORT SETTINGS button on the page allows for exporting data to a text file. This includes all of the ESO system parameters in addition to the information displayed on this page.

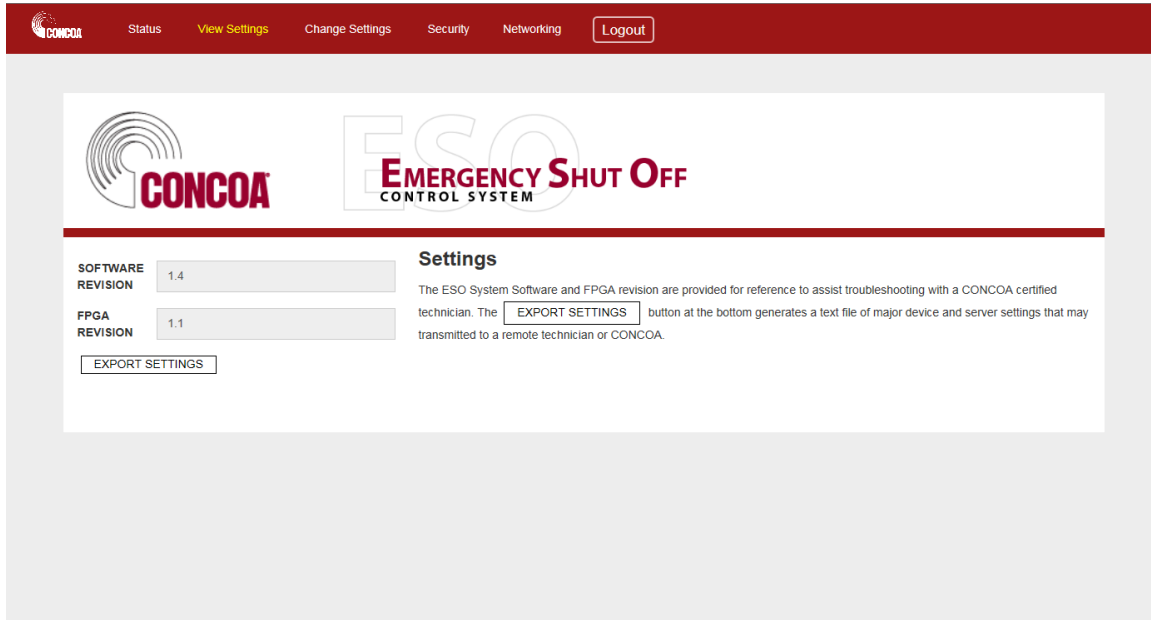

Figure 11

## WEB SERVER - CHANGE SETTINGS TAB

The ESO Change Settings tab contains five pages comprising all the system I/O configuration information.

These five pages are:

- Configuration
- Inputs
- Pneumatic Shutoff
- Output Relays
- Email Alerts

See instructions for each page below.

## WEB SERVER CHANGE SETTINGS TAB: CONFIGURATION PAGE

The ESO Configuration page shows the current settings for the date, time and system ID.

To set the date and time, enter the date in the format YYYY/MM/DD. The time should be entered as HH:MM, with a leading zero for the first nine hours. Click “SET” to submit.

When utilizing more than one ESO system, the System ID can be used to differentiate each ESO system in the email subject line. The settings are changed by entering the appropriate values in the text box and clicking the SET button. The CANCEL button will restore the current settings if any have been made in the browser but not committed. The CLEAR LOG button will permanently erase the event log.

The screenshot displays the 'Change Settings' tab of the ESO Configuration page. The navigation bar includes 'Status', 'View Settings', 'Change Settings', 'Security', and 'Networking', with a 'Logout' button. Below the navigation bar, the 'Configuration' tab is selected, showing options for 'Inputs', 'Pneumatic Shutoff', 'Output Relays', and 'Email Alerts'. The main content area features the CONCOA logo and the 'EMERGENCY SHUT OFF CONTROL SYSTEM' logo. The 'Configuration' section contains three input fields: 'DATE' (2015/08/31), 'TIME' (14:56), and 'SYSTEM ID' (0). Below these fields are three buttons: 'SET', 'CANCEL', and 'CLEAR LOG'. A paragraph of text explains the current settings and provides instructions for changing them, including the format for date and time. A final paragraph states that clicking the 'CLEAR LOG' button will permanently erase the event log.

Figure 12

# WEB SERVER CHANGE SETTINGS TAB: INPUTS PAGE



The ESO Inputs page shows the current settings for each of the eight system inputs. The settings may be changed by entering the appropriate value in the text box, selecting the appropriate value from the drop-down box, or by clicking the appropriate check box and clicking the SET button. The CANCEL button will restore the current settings if any have been made in the browser but not committed.

If an input is enabled, the status of that input will be shown on the alarm panel, reported on the status page, used in the pneumatic shutoff logic, used for output relays, and reported in email events. If an input is disabled, it will be ignored, and the LED will be turned off.

The name of the input is used on the status page and in any generated emails.

The normal condition of the input indicates the expected circuit continuity of the input (normally closed or normally open). When an input is in normal condition, its associated LED (on the front panel and status page) will show green. When the input exits its normal condition the indicator will show red. All inputs are configured at the factory for normally closed operation.

Input 7 is dedicated to the local E-STOP button. Input 8 is dedicated to the internal pressure switch for the pneumatic gas supply. If pneumatic gas pressure is too low, all connected valves will shut off.

---

Input	Enabled	Name	Normal Condition
1	<input type="checkbox"/>	<input type="text" value="Input 1"/>	<span style="border: 1px solid gray; padding: 2px;">Closed</span> ▼
2	<input type="checkbox"/>	<input type="text" value="Input 2"/>	<span style="border: 1px solid gray; padding: 2px;">Closed</span> ▼
3	<input type="checkbox"/>	<input type="text" value="Input 3"/>	<span style="border: 1px solid gray; padding: 2px;">Closed</span> ▼
4	<input type="checkbox"/>	<input type="text" value="Input 4"/>	<span style="border: 1px solid gray; padding: 2px;">Closed</span> ▼
5	<input type="checkbox"/>	<input type="text" value="Input 5"/>	<span style="border: 1px solid gray; padding: 2px;">Closed</span> ▼
6	<input type="checkbox"/>	<input type="text" value="Input 6"/>	<span style="border: 1px solid gray; padding: 2px;">Closed</span> ▼
7	<input checked="" type="checkbox"/>	<input type="text" value="Local e-stop button"/>	<span style="border: 1px solid gray; padding: 2px;">Closed</span> ▼
8	<input checked="" type="checkbox"/>	<input type="text" value="Pneumatic air pressure"/>	<span style="border: 1px solid gray; padding: 2px;">Closed</span> ▼

SET
CANCEL

**Inputs**

Settings for each of the eight inputs may be modified left. To change settings, enter the appropriate value in the text box, select the appropriate value from the drop-down, or click the appropriate checkbox and press the SET button. More than one setting may be changed at a time. The CANCEL button will restore the current settings if any changes have been made in the browser but not committed.

If an input is enabled, the status of the relay will be shown on the panel of the alarm itself (with a multi-color LED), reported on the status page of this website, used for output relays, and reported in e-mail events. If the input is not enabled, the condition of relay circuit will be ignored; the LED will not be lit in any condition, a change in condition will not generate e-mail notifications, and no output relays will be activated.

The name (up to 25 characters) of the relay is used on the status page of this website and in any e-mails generated.

The normal condition of the relay indicates the expected circuit continuity of the relay. When an input relay is in its normal condition (and it is enabled), the input multi-color LED for the input will show solid green on the alarm itself. When an input relay exits normal condition (and it is enabled), the multi-color LED for the input will show solid red. CONCOA indicators (such as pressure switch gauges, flow switches, and gas detectors) are typically configured at the factory for normally closed operation.

Input 7 is the local emergency stop button. Input 8 is the pressure switch for the pneumatic air supply. If pneumatic air pressure is lost, all connected valves will shut off.



Figure 13

# WEB SERVER CHANGE SETTINGS TAB: PNEUMATIC SHUT OFF PAGE

The ESO pneumatic shut off page shows the current configuration for each of the systems pneumatic shut off solenoid valves. Each row represents the configuration for the pneumatic shut off valve of that number. The settings may be changed by clicking the appropriate check box and clicking the SET button. The CANCEL button will restore the current settings if any have been made in the browser but not committed.

If an output is disabled, no pneumatic gas pressure will be supplied through the corresponding port.

For each enabled pneumatic shutoff, each checked (✓) input will be monitored, resulting in shut-off of the associated pneumatic valve upon an alarm condition. If input 8 (pneumatic gas pressure monitor) exits normal condition, all pneumatic shut-offs will be activated. This cannot be modified.

---

Pneumatic Shutoff	Enabled	Name	Input							
			1	2	3	4	5	6	7	8
1	<input checked="" type="checkbox"/>	Pneumatic Shutoff 1	<input checked="" type="checkbox"/>	<input checked="" type="checkbox"/>	<input checked="" type="checkbox"/>	<input checked="" type="checkbox"/>	<input checked="" type="checkbox"/>	<input checked="" type="checkbox"/>	<input checked="" type="checkbox"/>	<input checked="" type="checkbox"/>
2	<input checked="" type="checkbox"/>	Pneumatic Shutoff 2	<input checked="" type="checkbox"/>	<input checked="" type="checkbox"/>	<input checked="" type="checkbox"/>	<input checked="" type="checkbox"/>	<input checked="" type="checkbox"/>	<input checked="" type="checkbox"/>	<input checked="" type="checkbox"/>	<input checked="" type="checkbox"/>
3	<input checked="" type="checkbox"/>	Pneumatic Shutoff 3	<input checked="" type="checkbox"/>	<input checked="" type="checkbox"/>	<input checked="" type="checkbox"/>	<input checked="" type="checkbox"/>	<input checked="" type="checkbox"/>	<input checked="" type="checkbox"/>	<input checked="" type="checkbox"/>	<input checked="" type="checkbox"/>
4	<input checked="" type="checkbox"/>	Pneumatic Shutoff 4	<input checked="" type="checkbox"/>	<input checked="" type="checkbox"/>	<input checked="" type="checkbox"/>	<input checked="" type="checkbox"/>	<input checked="" type="checkbox"/>	<input checked="" type="checkbox"/>	<input checked="" type="checkbox"/>	<input checked="" type="checkbox"/>
5	<input checked="" type="checkbox"/>	Pneumatic Shutoff 5	<input checked="" type="checkbox"/>	<input checked="" type="checkbox"/>	<input checked="" type="checkbox"/>	<input checked="" type="checkbox"/>	<input checked="" type="checkbox"/>	<input checked="" type="checkbox"/>	<input checked="" type="checkbox"/>	<input checked="" type="checkbox"/>
6	<input checked="" type="checkbox"/>	Pneumatic Shutoff 6	<input checked="" type="checkbox"/>	<input checked="" type="checkbox"/>	<input checked="" type="checkbox"/>	<input checked="" type="checkbox"/>	<input checked="" type="checkbox"/>	<input checked="" type="checkbox"/>	<input checked="" type="checkbox"/>	<input checked="" type="checkbox"/>
7	<input checked="" type="checkbox"/>	Pneumatic Shutoff 7	<input checked="" type="checkbox"/>	<input checked="" type="checkbox"/>	<input checked="" type="checkbox"/>	<input checked="" type="checkbox"/>	<input checked="" type="checkbox"/>	<input checked="" type="checkbox"/>	<input checked="" type="checkbox"/>	<input checked="" type="checkbox"/>
8	<input checked="" type="checkbox"/>	Pneumatic Shutoff 8	<input checked="" type="checkbox"/>	<input checked="" type="checkbox"/>	<input checked="" type="checkbox"/>	<input checked="" type="checkbox"/>	<input checked="" type="checkbox"/>	<input checked="" type="checkbox"/>	<input checked="" type="checkbox"/>	<input checked="" type="checkbox"/>

**Pneumatic Shutoff**

Up to eight pneumatic shutoff solenoid valves may be configured left. Each row represents the configuration for the pneumatic shutoff valve of that number. To change settings, click the appropriate checkbox and press the  button. More than one setting may be changed at a time. The  button will restore the current settings if any changes have been made in the browser but not committed.

If an output is disabled, no pneumatic air will be supplied through the port.

Each input checked will be monitored for shutoff if it is enabled. If any of the selected inputs for a given shutoff exits its normal condition, that shutoff will be activated. If the selected input is disabled, it will be ignored, and treated, effectively, as though it were not checked. If input 8 (the pneumatic air pressure switch) exits normal condition, all shutoffs will necessarily be activated.

Figure 14



# WEB SERVER CHANGE SETTINGS TAB: OUTPUT RELAYS PAGE

The ESO output relays page shows the current configuration for each of the electrical output relays. Each row represents the configuration for the dry contact output relay of that number. The settings may be changed by selecting the appropriate value from the drop-down box, or clicking the appropriate check box and clicking the SET button. The CANCEL button will restore the current settings if any have been made in the browser but not committed.

If a dry contact output is disabled, the circuit will be open or closed at all times depending on the jumper setting.

The EVENT setting indicates the input conditions for which the output will send an alarm to an external device. If “Any” is selected, then the output will send an alarm if any of the checked (✓) inputs enters an alarm condition. If “All” is selected, then the output will send an alarm only if all of the checked (✓) inputs enter an alarm condition.

Each checked (✓) input will be monitored for an alarm condition only if the checked (✓) input is enabled (see figure 13). If the checked (✓) input is disabled, it will be ignored.

---

Dry Contact Output	Enabled	Event	Input							
			1	2	3	4	5	6	7	8
1	<input checked="" type="checkbox"/>	Any	<input checked="" type="checkbox"/>	<input type="checkbox"/>	<input type="checkbox"/>	<input type="checkbox"/>	<input type="checkbox"/>	<input type="checkbox"/>	<input type="checkbox"/>	<input type="checkbox"/>
2	<input checked="" type="checkbox"/>	Any	<input type="checkbox"/>	<input checked="" type="checkbox"/>	<input type="checkbox"/>	<input type="checkbox"/>	<input type="checkbox"/>	<input type="checkbox"/>	<input type="checkbox"/>	<input type="checkbox"/>
3	<input checked="" type="checkbox"/>	Any	<input type="checkbox"/>	<input checked="" type="checkbox"/>	<input type="checkbox"/>	<input type="checkbox"/>	<input type="checkbox"/>	<input type="checkbox"/>	<input type="checkbox"/>	<input type="checkbox"/>
4	<input checked="" type="checkbox"/>	Any	<input type="checkbox"/>	<input type="checkbox"/>	<input checked="" type="checkbox"/>	<input type="checkbox"/>	<input type="checkbox"/>	<input type="checkbox"/>	<input type="checkbox"/>	<input type="checkbox"/>
5	<input checked="" type="checkbox"/>	Any	<input type="checkbox"/>	<input type="checkbox"/>	<input type="checkbox"/>	<input checked="" type="checkbox"/>	<input type="checkbox"/>	<input type="checkbox"/>	<input type="checkbox"/>	<input type="checkbox"/>
6	<input checked="" type="checkbox"/>	Any	<input type="checkbox"/>	<input type="checkbox"/>	<input type="checkbox"/>	<input type="checkbox"/>	<input checked="" type="checkbox"/>	<input type="checkbox"/>	<input type="checkbox"/>	<input type="checkbox"/>
7	<input checked="" type="checkbox"/>	Any	<input type="checkbox"/>	<input type="checkbox"/>	<input type="checkbox"/>	<input type="checkbox"/>	<input type="checkbox"/>	<input checked="" type="checkbox"/>	<input type="checkbox"/>	<input type="checkbox"/>
8	<input checked="" type="checkbox"/>	Any	<input type="checkbox"/>	<input type="checkbox"/>	<input type="checkbox"/>	<input type="checkbox"/>	<input type="checkbox"/>	<input type="checkbox"/>	<input checked="" type="checkbox"/>	<input type="checkbox"/>

**Output Relays**

Up to eight dry contact relays may be configured left. Each row represents the configuration for the dry contact output relay of that number. To change settings, select the appropriate value from the drop-down or click the appropriate checkbox and press the  button. More than one setting may be changed at a time. The  button will restore the current settings if any changes have been made in the browser but not committed.

If an output is disabled, the circuit will be open or closed at all times depending on the jumper setting.

The event indicates the condition in which the output will exit its normal condition. If "All" is chosen, then all of the selected input relays must enter alarm condition for the output to exit its normal condition. If "Any" is chosen, then the output relay will exit its normal condition if any of the selected input relays exits its normal condition.

Each input checked will be monitored for alarm if it is enabled. If the selected input is disabled, it will be ignored, and treated, effectively, as though it were not checked.

Figure 15



## WEB SERVER CHANGE SETTINGS TAB: E-MAIL ALERTS PAGE

The ESO E-Mail Alerts page (see figure 16) shows the current configuration for the system email alerts. Each row represents the configuration for the email alert of that input number. The settings may be changed by entering the appropriate value in the text box, selecting the appropriate value from the drop-down box, or clicking the appropriate check box and clicking the SET button. The CANCEL button will restore the current settings if any have been made in the browser but not committed. Options common to all e-mail alerts (such as network settings, relay information, sender, and reply-to) may be configured in the Networking page.

If an alert is disabled, an email will not be sent regardless of the input conditions associated with the alert.

“Condition” indicates whether an email alert will be triggered when the described alarm condition occurs, when it is cleared, or both. Note that emails are sent only on the change of the entire state, not individual inputs.

The event indicates the condition in which the email alert will be triggered. If “All” is selected, then all of the selected inputs must enter alarm condition for the alert to be triggered. If “Any” is chosen, then any of the selected relays entering alarm condition will cause the alert to trigger.

Each checked (✓) input will be monitored for an alarm condition only if the checked (✓) input is enabled (see figure 13). If the checked (✓) input is disabled, it will be ignored.

If “Non-relay Events” is checked (✓), then the alert will also be triggered by any change in alarm condition unrelated to the selected inputs. These events include alarm silence and web based configuration changes.

The Subject text box adds a customizable subject to the email alert and the “To:” allows the user to assign recipients. Multiple email addresses are permissible in the “To” field and should be separated by a semicolon. There is a 256 string max.



Alert	Enabled	Condition	Event	Input								Non-relay Events	E-mail options	
				1	2	3	4	5	6	7	8		Subject	Recipients
1	<input type="checkbox"/>	On alarm ▼	All ▼	<input type="checkbox"/>	<input type="checkbox"/>	<input type="checkbox"/>	<input type="checkbox"/>	<input type="checkbox"/>	<input type="checkbox"/>	<input type="checkbox"/>	<input type="checkbox"/>	<input type="checkbox"/>		
2	<input type="checkbox"/>	On alarm ▼	All ▼	<input type="checkbox"/>	<input type="checkbox"/>	<input type="checkbox"/>	<input type="checkbox"/>	<input type="checkbox"/>	<input type="checkbox"/>	<input type="checkbox"/>	<input type="checkbox"/>	<input type="checkbox"/>		
3	<input type="checkbox"/>	On alarm ▼	All ▼	<input type="checkbox"/>	<input type="checkbox"/>	<input type="checkbox"/>	<input type="checkbox"/>	<input type="checkbox"/>	<input type="checkbox"/>	<input type="checkbox"/>	<input type="checkbox"/>	<input type="checkbox"/>		
4	<input type="checkbox"/>	On alarm ▼	All ▼	<input type="checkbox"/>	<input type="checkbox"/>	<input type="checkbox"/>	<input type="checkbox"/>	<input type="checkbox"/>	<input type="checkbox"/>	<input type="checkbox"/>	<input type="checkbox"/>	<input type="checkbox"/>		
5	<input type="checkbox"/>	On alarm ▼	All ▼	<input type="checkbox"/>	<input type="checkbox"/>	<input type="checkbox"/>	<input type="checkbox"/>	<input type="checkbox"/>	<input type="checkbox"/>	<input type="checkbox"/>	<input type="checkbox"/>	<input type="checkbox"/>		
6	<input type="checkbox"/>	On alarm ▼	All ▼	<input type="checkbox"/>	<input type="checkbox"/>	<input type="checkbox"/>	<input type="checkbox"/>	<input type="checkbox"/>	<input type="checkbox"/>	<input type="checkbox"/>	<input type="checkbox"/>	<input type="checkbox"/>		
7	<input type="checkbox"/>	On alarm ▼	All ▼	<input type="checkbox"/>	<input type="checkbox"/>	<input type="checkbox"/>	<input type="checkbox"/>	<input type="checkbox"/>	<input type="checkbox"/>	<input type="checkbox"/>	<input type="checkbox"/>	<input type="checkbox"/>		
8	<input type="checkbox"/>	On alarm ▼	All ▼	<input type="checkbox"/>	<input type="checkbox"/>	<input type="checkbox"/>	<input type="checkbox"/>	<input type="checkbox"/>	<input type="checkbox"/>	<input type="checkbox"/>	<input type="checkbox"/>	<input type="checkbox"/>		

SET CANCEL

Figure 16

## WEB SERVER - NETWORKING PAGE

The ESO Networking page (see figure 17) shows the IP and SMTP settings for the system. The current IP and SMTP settings are displayed on the right. The settings may be changed by editing one or more of the options in the left box and clicking the SET button. The CANCEL button will restore the current settings if any have been made in the browser but not committed.

Any change to the IP settings will immediately cause the server to restart; therefore, please ensure access to the new network location prior to clicking the SET button. Note that if DHCP CLIENT is set to ON, then all IP text boxes will be ignored, and the ESO will seek IP settings from a DHCP server.

The ESO can send e-mail alerts in real time as certain events occur. Up to eight e-mail alerts can be configured on the E-Mail Alerts page described in the previous section. Email settings on this page apply to all e-mail alerts.

The ESO features an on-board SMTP server that will directly connect to recipient hosts without an intermediary relay. The FROM and REPLY TO data entered must be valid e-mail addresses. The SERVER PORT determines the TCP port on the recipient host to which the ESO server will connect to open a connection. LOCAL PORT sets the port on the ESO server from which this connection will attempt to originate. OVERRIDING DOMAIN indicates how the ESO server will identify itself to the target host. To force all mail to be sent via relay regardless of the recipient domain, enter the name or address of the relay server in RELAY ADDRESS. If this setting is blank, the SMTP server on the ESO will attempt to open a connection directly to the recipient domain. RELAY PORT controls the port on the relay server to which the ESO will connect. The scroll box below these settings shows the SMTP log for troubleshooting purposes.



New Settings	
DHCP CLIENT	<input type="radio"/> ON <input checked="" type="radio"/> OFF
IP ADDRESS:	<input type="text" value="192.168.0.220"/>
SUBNET MASK	<input type="text" value="255.255.255.0"/>
DEFAULT GATEWAY:	<input type="text" value="192.168.0.100"/>
PRIMARY DNS:	<input type="text"/>
SECONDARY DNS:	<input type="text"/>
<input type="button" value="SET"/> <input type="button" value="CANCEL"/>	

Current IP Settings	
MAC ADDRESS	<input type="text" value="00:80:a3:90:78:4e"/>
IP ADDRESS	<input type="text" value="192.168.0.220"/>
SUBNET MASK	<input type="text" value="255.255.255.0"/>
DEFAULT GATEWAY	<input type="text" value="192.168.0.100"/>
PRIMARY DNS	<input type="text"/>
SECONDARY DNS	<input type="text"/>

New Email Settings	
FROM:	<input type="text"/>
TEST RECIPIENT:	<input type="text"/>
REPLY TO:	<input type="text"/>
<b>ADVANCED SETTINGS</b>	
SERVER PORT:	<input type="text" value="25"/>
LOCAL PORT:	<input type="text" value="&lt;Random&gt;"/>
OVERRIDING DOMAIN:	<input type="text"/>
RELAY ADDRESS	<input type="text"/>
RELAY PORT:	<input type="text" value="25"/>

Current Email Settings	
FROM:	<input type="text"/>
TEST RECIPIENT:	<input type="text"/>
REPLY TO:	<input type="text"/>
<b>ADVANCED SETTINGS</b>	
SERVER PORT:	<input type="text" value="25"/>
LOCAL PORT:	<input type="text" value="&lt;Random&gt;"/>
OVERRIDING DOMAIN:	<input type="text"/>
RELAY ADDRESS	<input type="text"/>
RELAY PORT:	<input type="text" value="25"/>

Figure 17

# WEB SERVER - SECURITY PAGE

The ESO Security page (see figure 18) shows the security settings for the system. If the Admin security is enabled, authentication for that user will be required to browse the Change Settings, Security, and Networking Pages of the ESO server. If Operator security is enabled, authentication for that user or as Admin will be required to browse Status and to View Settings. Refer to the ESO Webserver Configuration Instructions for factory default security settings.

To enable security, enter a password (twice), click the desired Security Enabled box, and click the SET button. The CANCEL button will restore the current settings if any have been made in the browser but not committed. Note that to enable Operator security, Admin security must also be enabled.

To disable security, clear the appropriate Security Enabled box and click the SET button. Note that Operator security must be disabled before Admin security can be disabled.

User names and passwords are case-sensitive, and the user names Admin and Operator may not be changed. Authentication requires cookies to be enabled on the browser. CONCOA strongly recommends that Admin security be enabled at all times to prevent inadvertent changes to settings that may affect the functionality of the product. For security purposes, be sure to click the LOGOUT button or close the browser. If you have been locked out of the ESO, contact CONCOA.

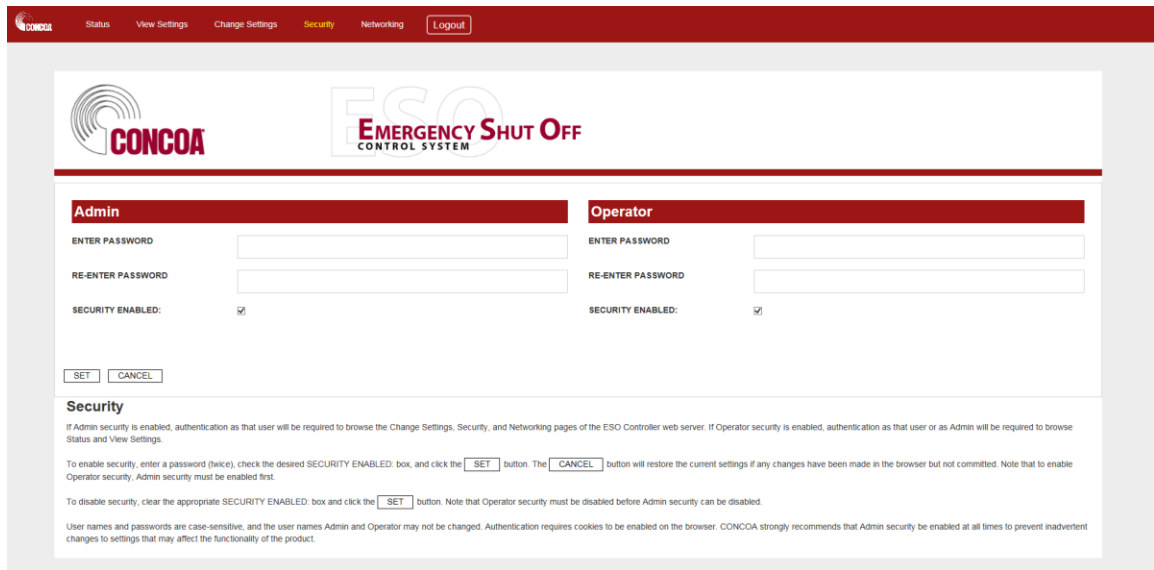

Figure 18

## WARRANTY INFORMATION

This equipment is sold by CONTROLS CORPORATION OF AMERICA under the warranties set forth in the following paragraphs. Such warranties are extended only with respect to the purchase of this equipment directly from CONTROLS CORPORATION OF AMERICA or its Authorized Distributors as new merchandise and are extended to the first Buyer thereof other than for the purpose of resale.

For a period of one (1) year from the date of original delivery (90 days in corrosive service) to Buyer or to Buyer's order, this equipment is warranted to be free from functional defects in materials and workmanship and to conform to the description of this equipment contained in this manual and any accompanying labels and/or inserts, provided that the same is properly operated under conditions of normal use and that regular periodic maintenance and service is performed or replacements made in accordance with the instructions provided. The foregoing warranties shall not apply if the equipment has been repaired: other than by CONTROLS CORPORATION OF AMERICA or a designated service facility in accordance with written instructions provided by CONTROLS CORPORATION OF AMERICA; or altered by anyone other than CONTROLS CORPORATION OF AMERICA; or if the equipment has been operated under improper conditions or outside published specifications; or if the equipment has been damaged or does not function due to improper installation, improper supply of required utilities, accident, abuse, misuse, natural disaster, insufficient or excessive electrical supply, abnormal mechanical or environmental conditions, or debris or particles in the gas or liquid source of supply.

CONTROLS CORPORATION OF AMERICA's sole and exclusive obligation and Buyer's sole and exclusive remedy under the above warranties is limited to repairing using new or reconditioned parts or replacing, free of charge except for labor if permanently installed for the continuous supply of gas by other than a technician certified by CONTROLS CORPORATION OF AMERICA specifically to do so, at CONTROLS CORPORATION OF AMERICA's option, the equipment or part, which is either (1) reported to its Authorized Distributor from whom purchased, and which if so advised, is returned with a statement of the observed deficiency, and proof of purchase of equipment or part not later than seven (7) days after the expiration date of the applicable warranty, to the nearest designated service facility during normal business hours, transportation charges prepaid, and which upon examination, is found not to comply with the above warranties with return trip transportation charges for the equipment or part paid by Buyer or (2) in the case of designated equipment permanently installed for the continuous supply of gas, reported to an Authorized Service Center with proof of initial installation no later than seven (7) days after the expiration date of the applicable warranty, and which is evaluated for compliance with the above warranties by technician certified by CONTROLS CORPORATION OF AMERICA, and which is determined by CONTROLS CORPORATION OF AMERICA based on said evaluation to be non-compliant.

**CONTROLS CORPORATION OF AMERICA SHALL NOT BE OTHERWISE LIABLE FOR ANY DAMAGES INCLUDING BUT NOT LIMITED TO: INCIDENTAL DAMAGES, CONSEQUENTIAL DAMAGES, OR SPECIAL DAMAGES, WHETHER SUCH DAMAGES RESULT FROM NEGLIGENCE, BREACH OF WARRANTY OR OTHERWISE.**

**THERE ARE NO EXPRESS OR IMPLIED WARRANTIES WHICH EXTEND BEYOND THE WARRANTIES HEREINABOVE SET FORTH. CONTROLS CORPORATION OF AMERICA MAKES NO WARRANTY OF MERCHANTABILITY OR FITNESS FOR A PARTICULAR PURPOSE WITH RESPECT TO THE EQUIPMENT OR PARTS THEREOF.**



Controls Corporation of America  
1501 Harpers Road  
Virginia Beach, Va. 23454

***CE DECLARATION OF CONFORMITY***  
*In accordance with ISO/IEC 17050*

The 585 Series Emergency Shut Off System is compliant with the CE directives and standards listed below:

**Directives:**

- Electromagnetic Compatibility (2004/108/EC)
- Low-Voltage (2006/95/EC)
- RoHS (2002/95/EC)

**Standards:**

- EMC: EN61326-1
- EMC: EN61000-4, EN61000-6
- EMC: CIPSR-11
- Safety: EN 61010-1

  
\_\_\_\_\_  
QUALITY MANAGER



## **Certified ISO 9001**

Controls Corporation of America

1501 Harpers Road Virginia Beach, VA 23454

Telephone 1-800-225-0473 or 757-422-8330 • Fax 757-422-3125

[www.concoa.com](http://www.concoa.com)