



CryoWiz™ Liquid Nitrogen Cryogenic Switchover

Controls Corporation of America
1501 Harpers Road • Virginia Beach, VA 23454
Telephone 1-800-225-0473 or 757-422-8330 • Fax 757-422-3125
www.concoa.com



Nov 2024

Rev Q

This page intentionally left blank.

Table of Contents

| | |
|---|----|
| Safety | 4 |
| User Responsibility | 6 |
| Description of Product | 6 |
| Features – Operation from Cryogenic Liquid Nitrogen Sources | 6 |
| Features – High Flow Cryogenic Valves | 6 |
| Features – Compact Enclosure with Condensate Drain | 6 |
| Features – Insulated Switching Mechanism..... | 6 |
| Features – Switchover | 6 |
| Features – Oxygen Deficiency Monitor Input..... | 7 |
| Features – Manual Bank Switching | 7 |
| Features – Purging | 7 |
| Features – Units of Measure..... | 7 |
| Features – Security Lockout | 7 |
| Features – Alarm Notification | 7 |
| Features – Ethernet Port / Web Server..... | 7 |
| Features – USB Port | 7 |
| Features – Relief Valve Overpressure Protection | 7 |
| Modes of Operation – On Demand Mode & Display When in On Demand Mode..... | 8 |
| Modes of Operation – Keep Full Mode & Display When in Keep Full Mode..... | 10 |
| Installing the CryoWiz™ | 11 |
| General Arrangement | 11 |
| Left Side Detail | 12 |
| Right Side Detail | 13 |
| Back Detail Showing Mounting Tabs | 14 |
| Connecting Inlets and Outlets | 15 |
| Installing Pipe Thread Connections | 15 |
| Connecting the Condensation Drain Line..... | 15 |
| Connecting the Dry Nitrogen Line..... | 15 |
| Connecting the Relief Valve Vent Line..... | 16 |
| Connecting the Hot Gas Purge Vent Line..... | 16 |
| Connecting an Oxygen Deficiency Monitor | 17 |
| Connecting a Remote Alarm | 18 |
| DIP Switches | 19 |
| SW2-1 - Keypad Lockout..... | 20 |
| SW3-1 - Alarm Configuration | 20 |
| SW3-2 – Audible Alarm On/Off..... | 20 |
| Setting Remote Alarm Outputs..... | 21 |
| Installing Real Time Clock Backup Batteries | 22 |
| Connecting Power | 23 |
| CryoWiz™ Startup | 23 |
| Operating the CryoWiz™ | 24 |
| Alarm Conditions..... | 25 |
| Communication Mode..... | 26 |
| Connecting the Web Server | 26 |
| Power Requirements | 26 |
| Service..... | 26 |
| Factory Default Settings | 26 |
| Liquid Nitrogen Reference Data | 27 |
| CE Declaration of Conformity..... | 28 |
| Warranty..... | 29 |



SAFETY

Handling Liquid Nitrogen

Nitrogen is a colorless, odorless, and tasteless gas. Liquid nitrogen (LN2) is a potential asphyxiate and may cause severe frostbite. Please observe all proper safety precautions to ensure proper handling of LN2. Consult your local LN2 dealer for detailed handling instructions.

Cryogenic liquid containers (dewars) must be operated in accordance with the manufacturer's instructions. Dewars must be kept in a well-ventilated space where they are protected from the weather and are away from any sources of heat.

Nitrogen is a potential asphyxiate and can cause rapid suffocation without warning. Store and use it in area with adequate ventilation. DO NOT vent the container or system in confined spaces. DO NOT enter confined spaces where gas may be present unless the area has been well ventilated. If inhaled, remove to fresh air. If not breathing, give artificial respiration. If breathing is difficult, supplemental oxygen may be required. SEEK MEDICAL ATTENTION IMMEDIATELY.

LN2 can cause severe frostbite to the eyes or skin. DO NOT touch frosted pipes, hose assemblies or valves. In case of frostbite, consult a physician at once. If a physician is not readily available, warm the affected areas with water that is near body temperature.

Never place LN2 in a sealed container without a pressure relief device. The expansion of LN2 to N2 gas is approximately 1 to 700. When handling LN2, the most important safety aspects to consider are adequate ventilation and eye and skin protection. Although nitrogen gas is non-toxic, it is dangerous in that the gas will displace the oxygen in ambient air. Therefore, it is imperative that cryogenic supply and storage dewars be stored and operated in open and well-ventilated areas. Oxygen Deficiency Monitoring Equipment should be used in areas where use of LN2 poses the risk of creating an oxygen deficient atmosphere. Never enter a space where oxygen deficiency is detected.

Persons transferring LN2 should make every effort to protect the eyes and skin from accidental contact with liquid or cold gas. Protect the eyes with a full-face shield. Safety glasses are not adequate. Always wear cryogenic gloves or equivalent when handling anything that is or may have been in contact with the liquid, cold gas, cold pipes, or cold equipment. Long sleeve shirts and trousers without cuffs that are of sufficient length to prevent liquid from entering the shoes are recommended.

Notice

The CryoWiz™ is intended for low pressure 22 to 35 PSIG Cryogenic Liquid Nitrogen Applications



Basic safety precautions must be followed to reduce the risk of fire, electrical shock, or injury.

- Connect the CryoWiz™ wall transformer to a 120 VAC or 220 VAC electrical outlet (see “Power Requirements” section). CONNECTION TO AN INCORRECT VOLTAGE CAN CAUSE SERIOUS DAMAGE TO THE PRODUCT AND WILL VOID ANY WARRANTY.
- Install the CryoWiz™ where the ambient temperature range is between 0° F and 140° F.
- Do not connect to cryogenic liquid sources lower than 22 PSIG or higher than 35 PSIG.
- Do not install this product in a hazardous environment.
- If product appears damaged in any way, do not use and request service from CONCOA.
- Connect system purge and relief valve outlets to appropriately sized piping to an exterior unobstructed vent.
- Consult your local LN2 Dealer for detailed handling instructions. Always open valves slowly when being used.
- Use appropriate protective equipment.
- Always be sure that a cylinder contains the correct gas before connecting it to any manifold.
- Always leak-test any manifold or distribution pipeline before using.
- Always close all cylinder valves before disconnecting cylinders from a manifold.
- Always remove all empty cylinders from a manifold before connecting full cylinders.
- Always check cylinders to be sure the cylinders are full before connecting to a manifold.
- All gas distribution piping systems must meet the appropriate industrial standards for the intended service and must be thoroughly cleaned before using. For the United States, some applicable safety rules and precautions are listed below:

1. American Society of Mechanical Engineers ASME B31.3 Process Piping; ASME Three Park Avenue
2. New York, NY 10016-5990
3. Local Ordinances
4. O.S.H.A. Standard 29 CFR
5. C.G.A. Pamphlet C-4, American National Standard Method of Marking Portable Compressed Gas Containers to Identify the Material Contained.
6. C.G.A. Pamphlet G-4.1, Equipment Cleaned for oxygen service.
7. C.G.A. Pamphlet P-12, Safe Handling of Cryogenic Liquids.
8. C.G.A. Safety Bulletin SB-2, Oxygen Deficient Atmospheres.

C.G.A. Pamphlets can be obtained from the Compressed Gas Association, 1235 Jefferson Davis Highway, Arlington, VA 22202-3239, and (703) 979-0900. Publications: (703) 979-4341. Fax: (703) 979-0134

USER RESPONSIBILITY

Service and Installation of this product should only be performed by CONCOA or an authorized CONCOA Service Center technician having extensive knowledge of cryogenic LN2 installations and systems. Requests for service may be made using the following methods of contact:

CUSTOMER SERVICE: 1-800-225-0473
CONCOA's FAX: 1-757-422-3125
CONCOA's E-MAIL: info@concoa.com

CONCOA accepts no responsibility for damage or injury if this product is modified in any way. CONCOA assumes/accepts no liability or responsibility for damage to individuals or equipment that may occur when using this product.

DESCRIPTION OF PRODUCT

The CryoWiz™ is a cryogenic switchover used to monitor, control, and switch the flow of cryogenic liquid nitrogen (LN2) from two independent banks while maintaining an uninterrupted supply.

It consists of four electronically controlled pneumatic valves, two of which are the inlet valves that control the flow of cryogenic LN2 to the outlet on the bottom of the device. The other two are purge valves that will divert hot gas upward through fittings on the top of the device, away from the outlet.

The CryoWiz™ monitors LN2 supply and demand using a proprietary computer algorithm to deliver an uninterrupted supply of LN2 to the outlet of the device.

The status of the CryoWiz™ may be monitored remotely via the Ethernet port. A series of indicator lights shows the status of the system at any given time. In addition, the CryoWiz™ can interface with a CONCOA or other remote alarm.

The failsafe position of all valves is Normally Closed (N.C.). A power outage, a cessation of the dry nitrogen gas supply to the pneumatic valves, or an oxygen deficiency alert relayed to the CryoWiz™ will result in shutoff of the LN2 supply and the purge outlets.

FEATURES

Operation from Cryogenic Liquid Nitrogen Sources

LN2 dewars provide the Cryowiz™ with an inlet pressure of 22 to 35 PSI. LN2 sources above 35 PSI are not recommended. Pressures above 35 PSI will result in increased liquid wastage caused by increased flashing. Each LN2 source bank may be composed of an individual dewar or multiple dewars connected via an appropriate pipeline or manifold.

High Flow Cryogenic Valves

The CryoWiz™ uses high flow cryogenic valves. The cryogenic valves deliver an optimal supply of LN2 to the outlet with minimal disturbance in flow and virtually no heat transfer.

Compact Enclosure with Condensate Drain

The entire system is encased in a compact enclosure with limited wall space and with a condensate drain to eliminate moisture build-up.

Insulated Switching Mechanism

The Insulated Pneumatic Valve Block minimizes heat transfer, reduces condensation, and ensures optimal delivery of LN2

Switchover

Depletion of the primary LN2 supply is detected when low dewar pressure is observed or when a purge to reach the threshold temperature has timed out. The CryoWiz™ automatically switches to the reserve bank and maintains an uninterrupted LN2 supply. The CryoWiz™ will alarm audibly, indicate “ALARM” with a red light on the front graphic, indicate “REPLACE” with a red light for the depleted side on the front graphic, send an electronic signal to a remote alarm if one is connected, and switch to the reserve supply side.

Oxygen Deficiency Monitor Input

It is recommended that an output from an oxygen deficiency monitor be permanently connected to the CryoWiz™ for a safe and correct installation. The CryoWiz™ comes with a terminal strip under a cover on the left side of the enclosure to which the output contact from an oxygen deficiency monitor can be connected. When the oxygen deficiency monitor relay contact is broken, the red “O2” “ALERTS” light on the front graphic will illuminate, and the system will shut down until the alarm condition has been cleared (see section “Connecting an Oxygen Deficiency Monitor”).

Manual Bank Switching

It is possible to manually change the side from which LN2 is being drawn: press the “SOURCE” button on the front graphic. Switching will occur only if there is a sufficient LN2 supply on the reserve side.

Purging

The CryoWiz™ will automatically purge hot gas as needed to reach the desired temperature threshold for liquid delivery. Manual purging is possible by pushing and holding the “LEFT PURGE” or “RIGHT PURGE” button on the front graphic. The system will purge as long as the button is held.

Units of Measure

The units of measure for the CryoWiz™ are Celsius and PSI. They are not changeable. The displays of the units are available thru the Web Server.

Security Lockout

The CryoWiz™ has the ability to electronically lock-out the front panel buttons to discourage tampering. The factory default setting is OFF or disabled for this feature (see “Keypad Lockout” section for details).

Alarm Notification

The CryoWiz™ has a local audible and visual alarm for 5 conditions: 1) left bank depleted; 2) right bank depleted; 3) pneumatic supply pressure low; 4) cryogenic valve frozen; 5) oxygen deficiency relayed from a separate oxygen deficiency monitor. The CryoWiz™ is designed to interface with CONCOA remote alarms (e.g., CONCOA Altos 2 Alarm 5750025-01-000 or CONCOA Advantium 16 Alarm 5750164-01-000). The relay dry contact outputs from the CryoWiz™ can be configured as five individual alarms or a single alarm contact. Refer to the alarm instruction manual for wiring instructions (CONCOA instruction manual 99060025 [ADI0025] for the Altos 2 alarm, instruction manual 99069531 [ADI9531] for the Advantium 16 alarm). Note that because the Altos 2 alarm supports a maximum of 2 inputs, it would normally be configured to detect the left and right bank alarms only or the master alarm. The Advantium 16 supports a maximum of 16 inputs, and can handle all 5 CryoWiz™ alarms independently.

Ethernet Port / Web Server

The CryoWiz™ is equipped with an integral Web Server enabling remote monitoring of functions, E-mail alerts, and remote configuration. For more information on the Web Server feature, refer to the web server instruction manual included with the CryoWiz™ (CONCOA manual 99065774 [ADI5774]).

USB Port

The USB port should only be used by factory trained and authorized CONCOA Service Center technicians during factory warranty installations and system configuration.

Relief Valve Overpressure Protection

The CryoWiz™ is equipped with three 50 PSI cryogenic relief valves. The relief valves will protect the system from pressure increases that may occur from the vaporization of trapped cryogenic liquid during operation.

MODES OF OPERATION

On Demand Mode

In ON DEMAND mode, the CryoWiz™ supplies LN2 based on the demand for LN2. In this mode, the primary source inlet valve is maintained in the open position, flow being controlled by the connected device downstream of the CryoWiz™. The reserve source valve is maintained in the closed position. LN2 will flow when a valve on the connected device opens and allows LN2 to flow into the device. By monitoring the outlet pressure, the primary inlet LN2 temperature, and the amount of time the device is requesting LN2, the CryoWiz™ determines if the device is performing a quick chill, a defog, or is actually requiring a fill cycle.

If the CryoWiz™ determines that a fill cycle is required, the primary side purge valve will open, allowing purge gas to flow through the vent connection at the top of the enclosure. This results in a quick drop to the user-settable threshold temperature, and maximization of liquid flow.

If the CryoWiz™ determines that a quick chill, defog, or other temporary demand is required, the purge valve remains closed, and a purge is not performed, thus minimizing LN2 usage.

Display When in On Demand Mode

When configured for ON DEMAND mode, a green light indicating ON DEMAND will illuminate.

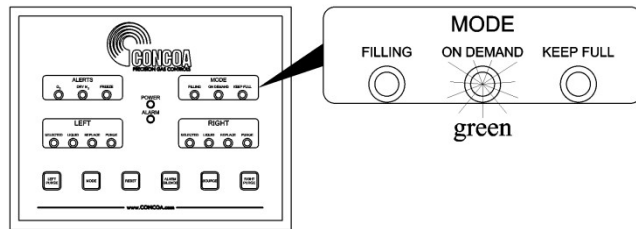

The side selected to be primary will be indicated by a green SELECTED light. Upon startup, the CryoWiz™ will default to LEFT side primary.

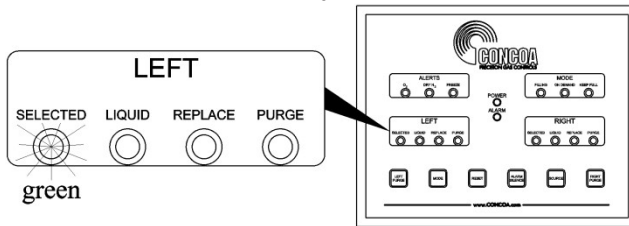

Each side that is sensed to be connected to a liquid supply source will have an illuminated LIQUID light. If the LIQUID light is yellow, that means the temperature at the source inlet valve is above the temperature optimal for liquid delivery (the threshold temperature). A green LIQUID light indicates that the threshold temperature has been reached, and conditions are optimal for liquid delivery.

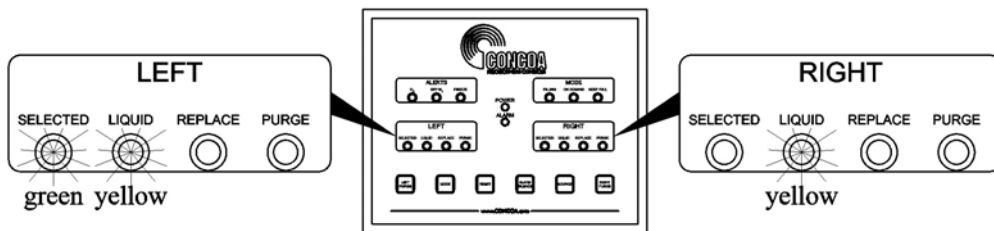

When demand for a fill cycle is sensed, the green FILLING light will blink for a period of time and then illuminate, and the user-settable defog timer will begin (this will not happen for a quick chill or defog).

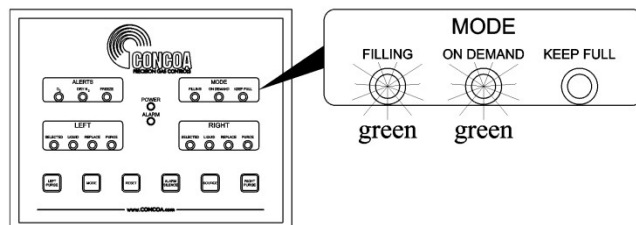

After the set time has expired, if the liquid temperature at the primary inlet valve has not reached the threshold temperature, a purge will begin. The selected bank's PURGE light will illuminate, and the CryoWiz™ will purge hot gas from the primary inlet.

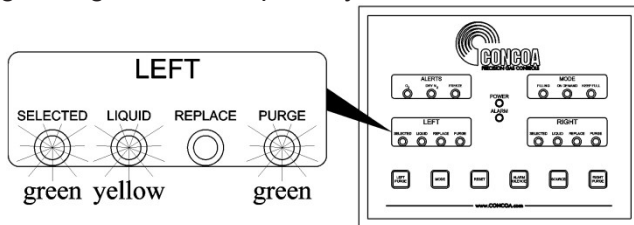

When the CryoWiz™ detects that the threshold temperature has been reached, the LIQUID light will turn green.

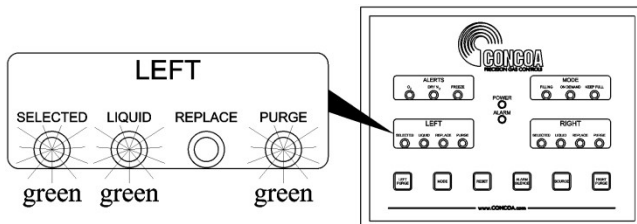

The purge valve will remain open and the PURGE light will remain on for a period of 15 seconds after the LIQUID light has changed to green.

When the CryoWiz™ senses that demand for liquid has ceased, the FILLING light will extinguish, and the temperature at the source valve will rise above the threshold temperature causing the LIQUID light to change from green to yellow.

If during a purge cycle the threshold temperature for the primary side is not reached in a specific period of time, the LIQUID light will be extinguished, the red REPLACE light will illuminate, and the audible alarm will sound. The green SELECTED light will switch to the reserve side, indicating that the CryoWiz™ has switched to supplying liquid from the reserve side. If the temperature at the reserve side source valve is above the threshold temperature, the reserve side will be purged, indicated by the purge light being illuminated until the threshold temperature is reached.

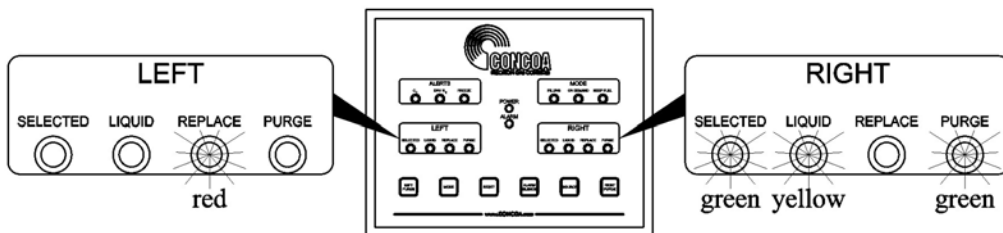

When the empty dewars are removed from the depleted side and full dewars are connected with their valves opened, the RESET button on the front graphic must be pushed. The CryoWiz™ will then detect the new source, turn on the LIQUID light for the replenished side, extinguish the REPLACE light, and cut off the audible alarm.

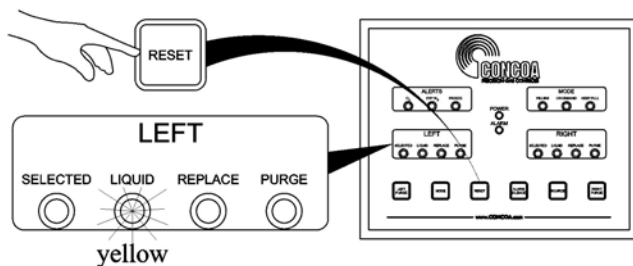

Keep Full Mode

In KEEP FULL mode, the CryoWiz™ maintains the primary source valve in the open condition and the reserve source valve in the closed position. In KEEP FULL mode, the system will purge the primary and reserve inlets when necessary to maintain liquid at both source valves. This ensures that liquid is instantaneously available from either side should there be a demand for it. When the CryoWiz™ senses that liquid is no longer present at the primary inlet; it will automatically switch to the reserve source and continue delivering LN2 to the outlet. In a high demand or continual use application, the amount of LN2 consumed by purging will be minimal relative to that used to supply the demand. It is recommended that in this mode, vacuum jacketed (VJ) supply hoses and vacuum jacketed downstream piping be used to minimize heat transfer and product loss. KEEP FULL mode is not recommended for installations where demand is sporadic, as the automatic purging may lead to excessive product loss.

Display When in Keep Full Mode

When configured for KEEP FULL mode, a green light indicating KEEP FULL and a green light for FILLING will illuminate. The FILLING light will blink for a period of time before illuminating continuously. The side selected to be primary will be indicated by a green SELECTED light. The reserve side SELECTED light will remain off. If the CryoWiz™ senses liquid at the source valves on both sides, the primary and reserve LIQUID lights will be illuminated green.

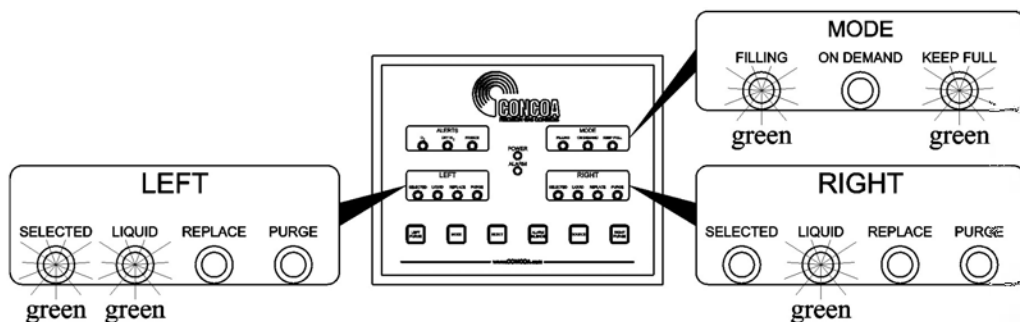

If liquid is not sensed at a source valve, the LIQUID light will illuminate yellow and the PURGE light will illuminate green until the system has purged hot gas from that side. When the CryoWiz™ senses that liquid has returned at the source valve, the LIQUID light will turn green and the PURGE light will turn off. For short periods of time during normal operation, the purge light on either side may illuminate indicating that the purge valve on that side has opened to expel hot gas and maintain continuous liquid supply. The LIQUID lights will switch from green to yellow during purging.

During a purge, if liquid does not return to the source valve on the selected side within a specified period of time (referred to as the PURGE TIMEOUT), the selected side LIQUID light will be extinguished, the red REPLACE light will illuminate, and the audible alarm will sound. The CryoWiz™ will switch to the reserve side, close the depleted side source valve, and open the reserve side source valve. The reserve side SELECTED light will illuminate. If liquid is not detected at the reserve side source valve, the reserve side purge light will remain on until liquid is detected. At that point, the reserve side LIQUID light will turn from yellow to green, and the purge light will turn off.

When the empty dewars are removed from the depleted side and full dewars are connected with their valves opened, the RESET button on the front graphic must be pushed. The CryoWiz™ will then detect the new source, turn on the LIQUID light for it, extinguish the REPLACE light, and cut off the audible alarm.

INSTALLING THE CRYOWIZ™

Installation of this product should be performed only by CONCOA or an authorized CONCOA factory trained technician. Knowledge of cryogenic installations and systems and certification as a CONCOA authorized installation and repair technician are required.

The Installer must read and understands these instructions.

The CryoWiz™ uses four mounting tabs to secure the system to a wall or to a panel - see the General Arrangement and the Back Detail Showing Mounting Tabs below. Mount the CryoWiz™ at a height convenient for making connections that also clears dewars and other systems in the installation space.

GENERAL ARRANGEMENT

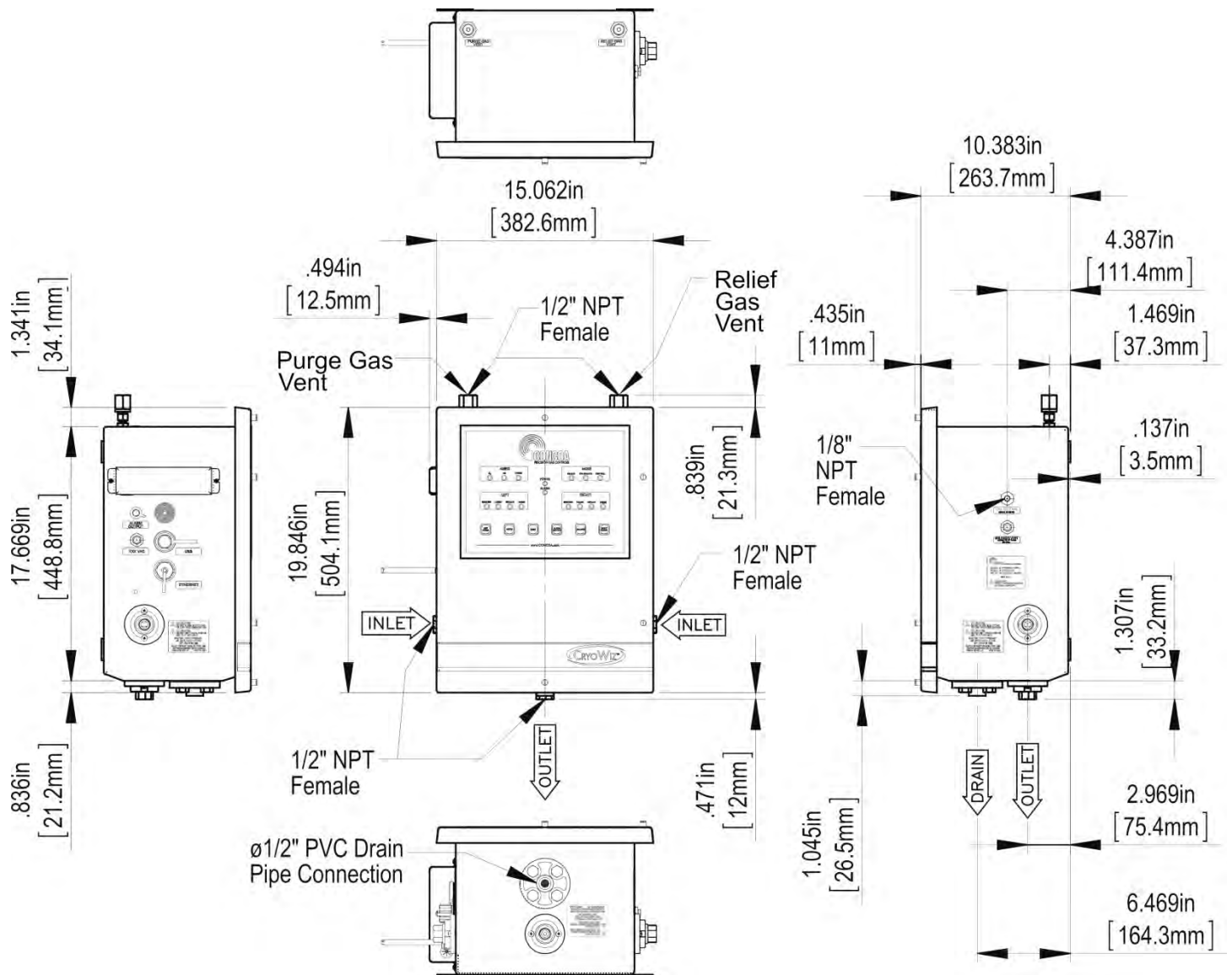

LEFT SIDE DETAIL

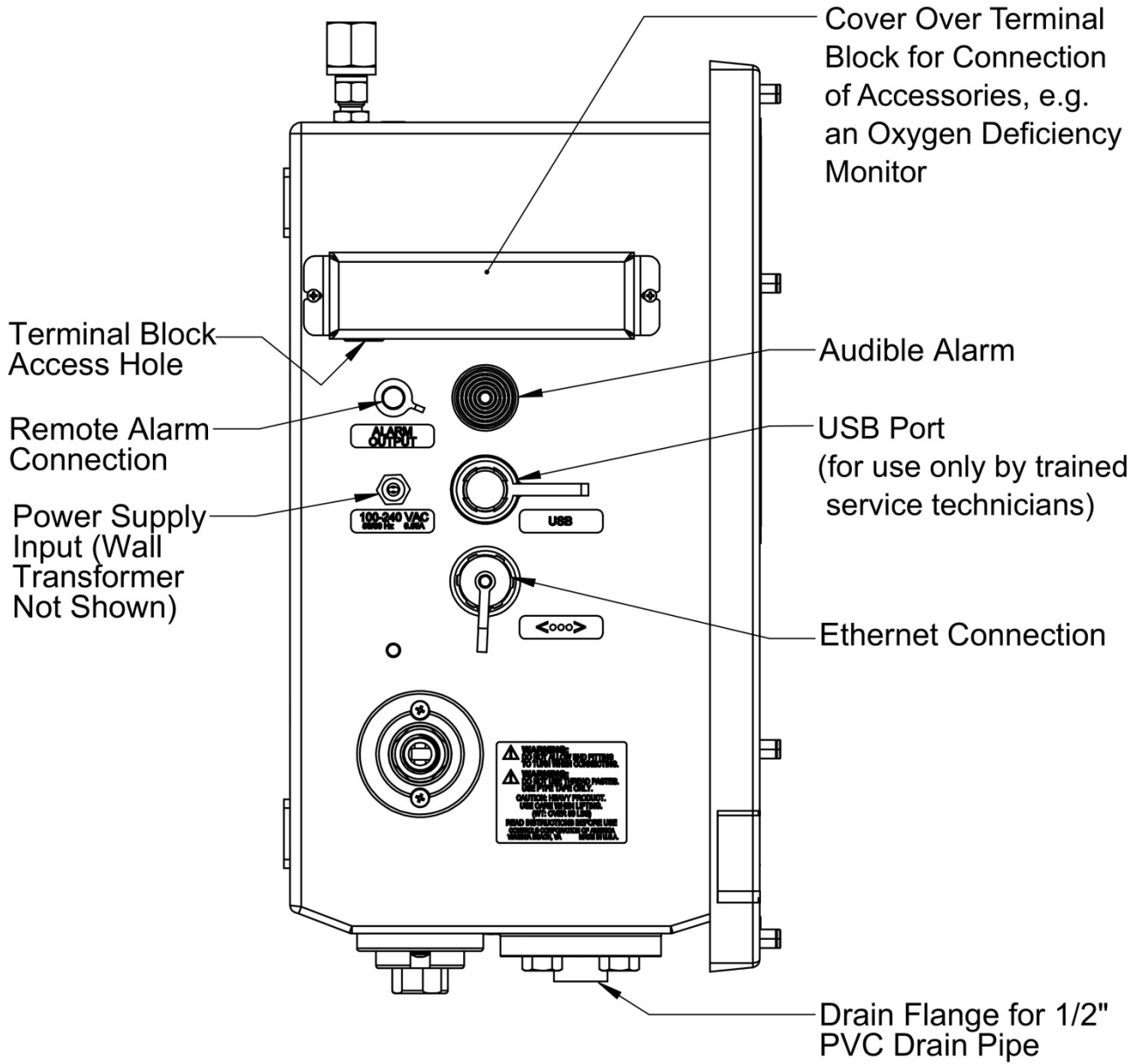

RIGHT SIDE DETAIL

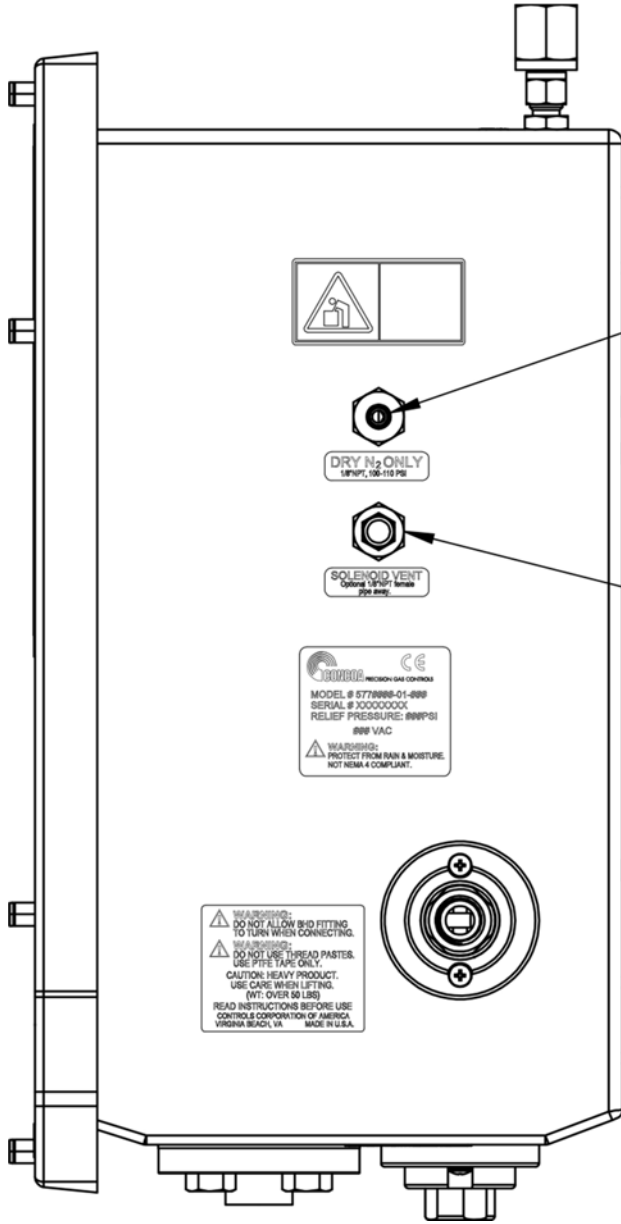

Dry Nitrogen Input:
ø1/8" NPT Female Port.
System requires
100-110 PSI compressed
dry nitrogen supply
to operate valves.

Solenoid Vent:
Remove muffler for
ø1/8" NPT female
pipe-away connection.

⚠ REASSEMBLING:
DO NOT ALLOW BRID FITTING
TO TURN WHEN CONNECTING.
⚠ REASSEMBLING:
DO NOT USE THREAD PASTER.
USE PTFE TAPE ONLY.
CAUTION: HEAVY PRODUCT.
USE CARE WHEN LIFTING.
(WT: OVER 50 LBS)
READ INSTRUCTIONS BEFORE USE
CONTROL & COMPONENTION OF AMERICA
VIRGINIA BEACH, VA MADE IN U.S.A.

BOMBARDIER MICRO-DIGI CONTROL
MODEL # 5778888-01-000
SERIAL # XXXXXXXX
RELIEF PRESSURE: 888PSI
888" VAC
⚠ WARNING:
PROTECT FROM RAIN & MOISTURE.
NOT NEMA 4 COMPLIANT.

BACK DETAIL SHOWING MOUNTING TABS

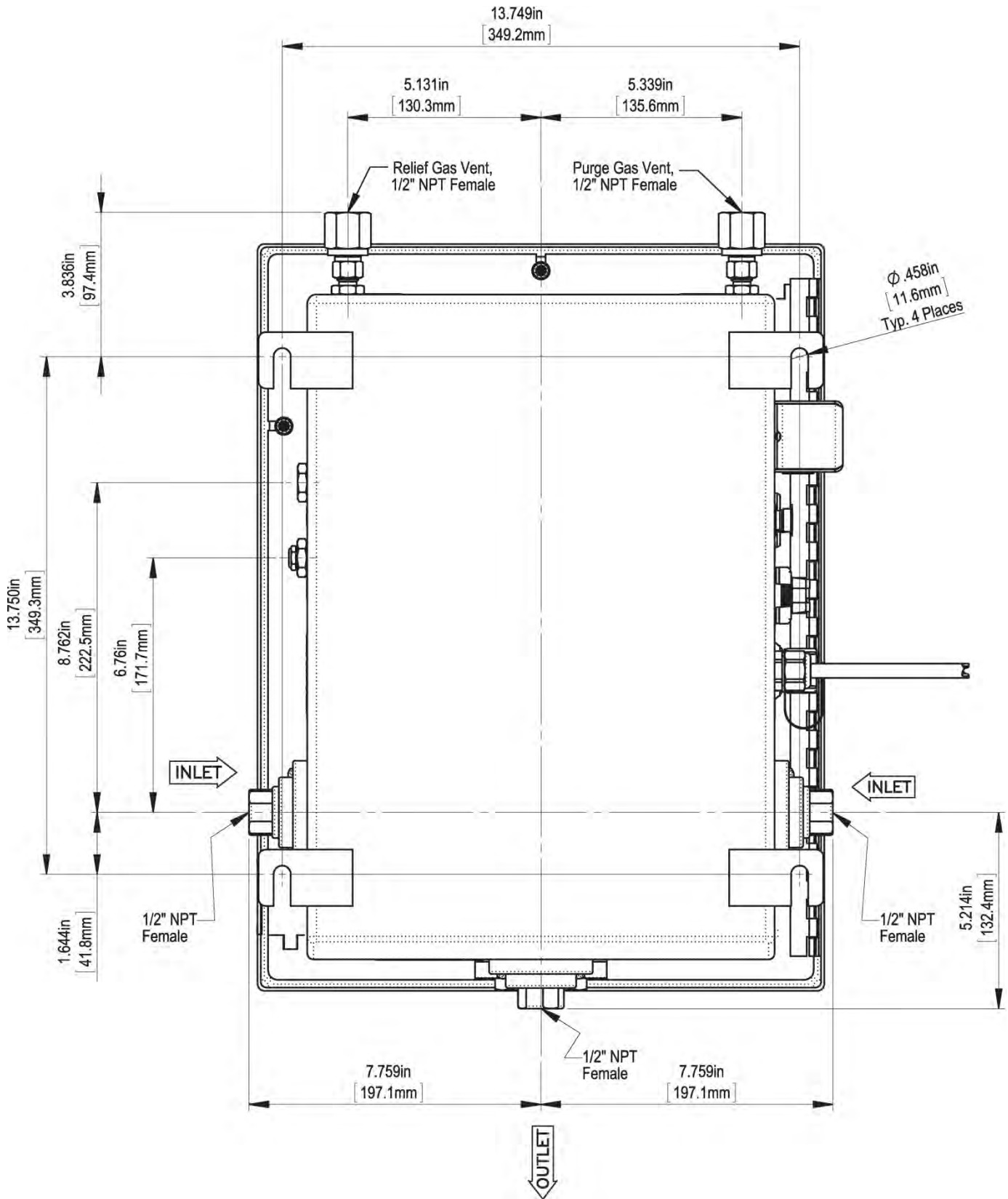

MECHANICAL CONNECTIONS

Connecting Inlets and Outlets

The CryoWiz™ inlets are located on the enclosure sides, and the outlet is on the bottom - see the General Arrangement and the Back Detail Showing Mounting Tabs. The inlets and the outlet on the CryoWiz™ are 1/2" female NPT ports, each of which may include an optional male CGA 295 fitting. Use two open end wrenches when tightening external devices to these fittings to prevent rotation of internal components. Do not use pipe wrenches.

Installing Pipe Thread Connections

NPT connections require the use of PTFE tape on the threads to make a gas tight seal. On stainless steel connections, PTFE tape also helps to prevent the connections from galling together when tightening or loosening. Follow the rules below when using PTFE tape:

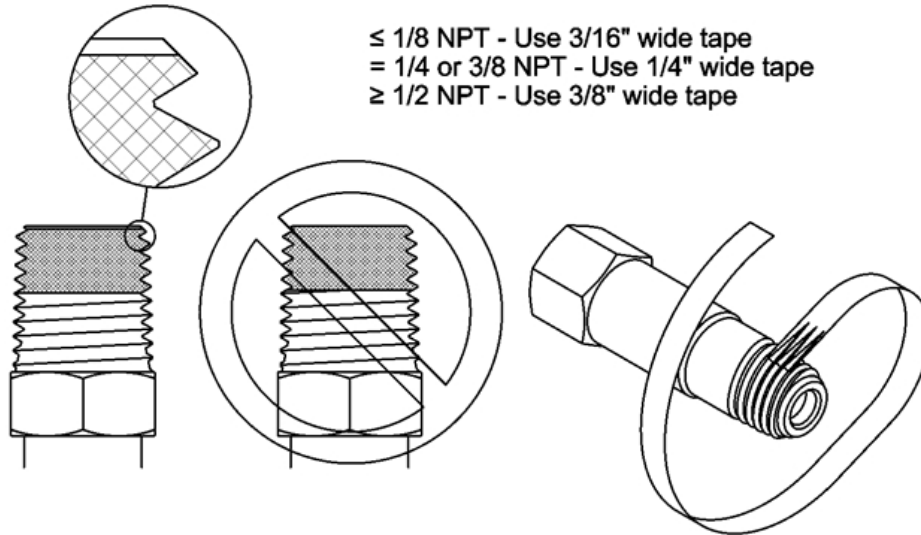

Taping procedure:

Before applying PTFE tape, inspect the NPT threads, and if necessary, clean the fitting to remove any dirt or thread sealant that remains on the threads. Start the PTFE tape on the first thread leaving a slight section of the chamfer exposed as shown in the figure above. Make sure the tape does not overlap the end of the fitting. As the tape is wrapped in the direction of the thread spiral, pull tightly on the end of the tape so that the tape conforms to the threads. Apply at least 2 but no more than 3 layers of tape to the threads. Cut off excess tape, and press the end firmly into the threads.

Connecting the Condensation Drain Line

The CryoWiz™ is well insulated and, in most installations, will frost very little internally. However, to prevent any moisture related condensation from accumulating inside, there is a 1/2" PVC flange on the enclosure bottom to which an appropriate drain line can be connected.

Connecting the Dry Nitrogen Line

The CryoWiz™ requires a dry nitrogen gas supply between 100 and 110 PSIG connected to the pneumatic dry nitrogen inlet port on the right side of the enclosure. Pneumatic dry nitrogen pressure must be present for operation of the system. Do not use any other pneumatic gas source – use only dry nitrogen.

The pneumatic dry nitrogen inlet is a female 1/8" NPT port. Use an appropriate hose for connection.

The CryoWiz™ comes with an internal pressure switch to monitor the pneumatic dry nitrogen supply pressure and to send an alarm signal if it drops below the pressure required by the device. The CryoWiz™ will not operate if the pressure drops below 90 psig.

Once connected, pressurize the pneumatic dry nitrogen line and check for leaks with liquid leak test solution. Rework any connections that show leaks.

Connecting the Relief Valve Vent Line

The CryoWiz™ is equipped with three 50 PSIG cryogenic relief valves. The relief valves protect the system from pressure increases that may occur due to the vaporization of trapped cryogenic liquid during operation. They are internally plumbed to a common ½" female NPT outlet on the top right side of the enclosure. Make sure that this is connected to an appropriately sized vent line and vented outside the building with a screened gooseneck. If combining both the relief and purge lines, use at least a ¾" trunk line to minimize purge times. The line must be at least 10' away from air intakes, windows, doorways, access points, and any confined space. Adherence to local codes and standards is required.

Connecting the Hot Gas Purge Vent Line

The CryoWiz™ is equipped with a hot gas bypass for both left and right sides. The hot gas bypass or purge vent lines are internally plumbed to a common ½" female NPT outlet on the top left side of the enclosure. This must be connected to an appropriately sized vent line and vented outside the building with a screened gooseneck. If combining both the relief and purge lines, use at least a ¾" trunk line to minimize purge times. The line must be at least 10' away from air intakes, windows, doorways, access points, and any confined spaces. Adherence to local codes and standards is required.

CONNECTING AN OXYGEN DEFICIENCY MONITOR

The CryoWiz™ is equipped with a Cryogenic Nitrogen cutoff feature. Note this feature is normally not used as it will obviously put the material being protected by the Cryogenic Nitrogen in jeopardy. For facilities that need this form of mitigation, a terminal strip is under a metal cover on the left side of the enclosure to which the normally open dry contact signal from an oxygen deficiency monitor can be connected. Remove the cover and connect the wires from the oxygen deficiency monitor to terminal 1 of the CryoWiz™ accessories circuit board as shown below and in Table 1.

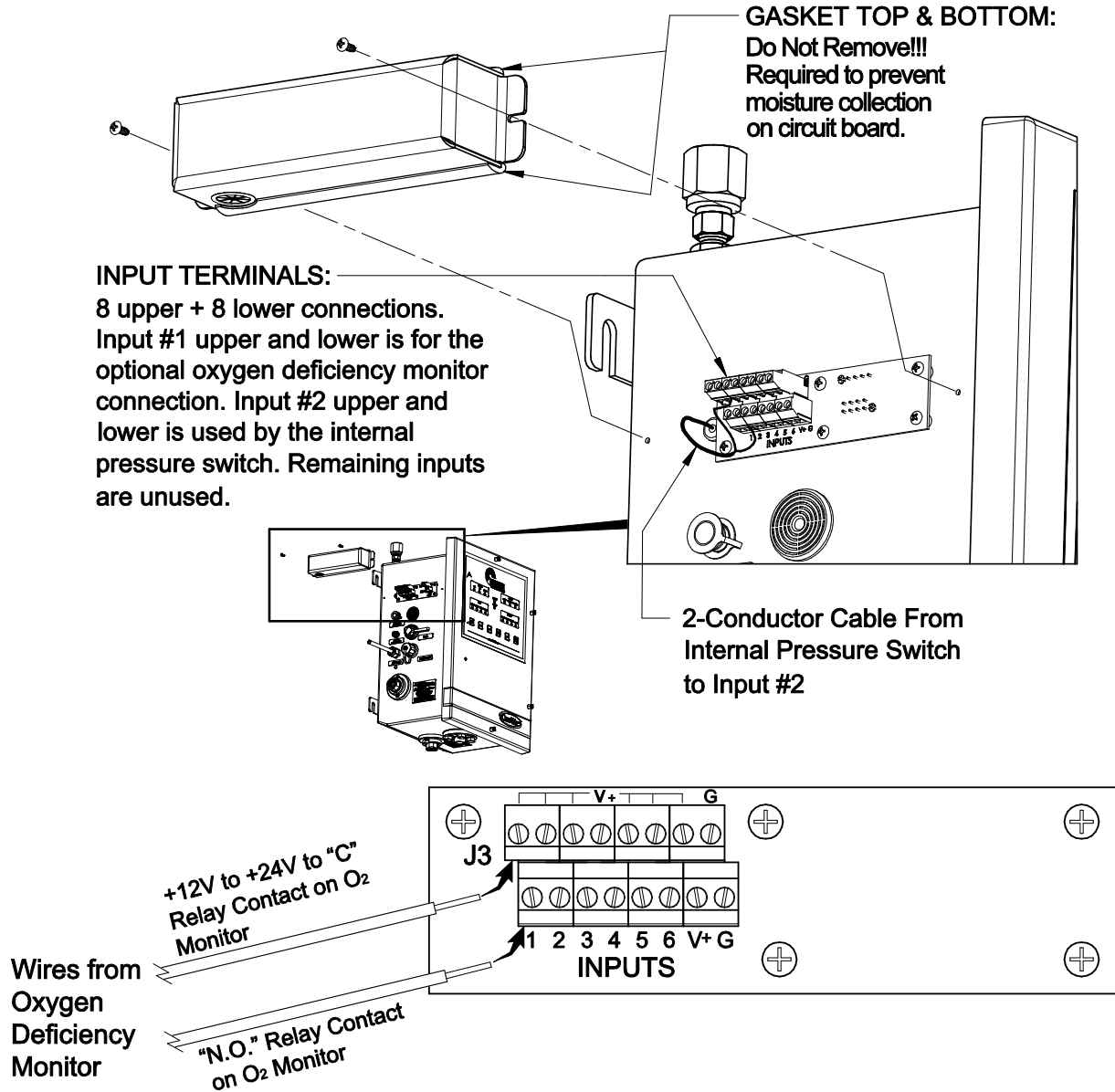

| Terminal Number | Terminal Number | Description |
|-----------------|-----------------|------------------------------|
| 1 | V+ | Oxygen Sensor |
| 2 | V+ | Dry Nitrogen Pressure Switch |
| 3 | V+ | Reserved |
| 4 | V+ | Reserved |
| 5 | V+ | Reserved |
| 6 | V+ | Reserved |

Table 1

CONNECTING A REMOTE ALARM

CONNECTING TO A REMOTE ALARM

The CryoWiz™ is capable of interfacing with CONCOA's Altos 2 and Advantium 16 Remote Alarms or other alarms. An 8-pin circular connector for connecting remote alarms is located on the left side of the enclosure. Because the Altos 2 alarm supports a maximum of 2 inputs, it would normally be configured to detect the left and right bank alarms only or the master alarm (see section "DIP Switches"). The Advantium 16 alarm supports a maximum of 16 inputs and can handle all 5 CryoWiz™ alarms independently.

Ready-made cable assemblies for connecting the CryoWiz™ to an Altos 2 or Advantium 16 Alarm are available from the factory. Refer to the alarm instruction manual indicated below for wiring instructions and for CONCOA cable part numbers, or contact your local CONCOA Distributor or call 1-800-225-0473 for information.

CONCOA Altos 2 Alarm 5750025-01-000: Instruction Manual 99060025 (ADI0025)

CONCOA Advantium 16 Alarm 5750164-01-000: Instruction Manual 99069531 (ADI9531)

The recommended cable size for alarm connections is 24 AWG, 4, 6 or 8 -conductor stranded wire (Alpha # 1216C or equivalent). The length of this cable should be limited to 1500 feet.

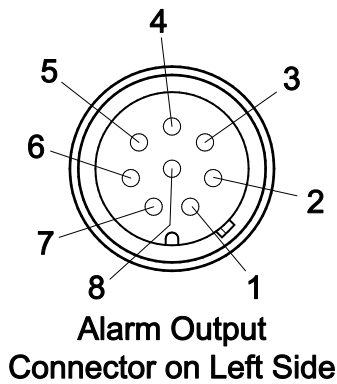

| ALARM OUTPUT CONNECTOR | |
|------------------------|-------------------------------|
| Pin | Function |
| 1 | Left Bank Depleted Alarm |
| 2 | Right Bank Depleted Alarm |
| 3 | +V In |
| 4 | Oxygen Deficiency Alarm Relay |
| 5 | Low Pneumatic Pressure Alarm |
| 6 | GND |
| 7 | Frozen Valve Alarm |
| 8 | unused |

Table 2

See also the section below entitled "SETTING REMOTE ALARM OUTPUTS" for information about setting the CryoWiz™ circuit board relays.

DIP SWITCHES

Make sure power is not supplied to the system. Open the front door by loosening the 4 screws on the front cover.

Dip Switch Settings

The keypad lockout, alarm configuration, and audible alarm silence features can be set using dipswitches on the circuit board. See figure below and Table 3.

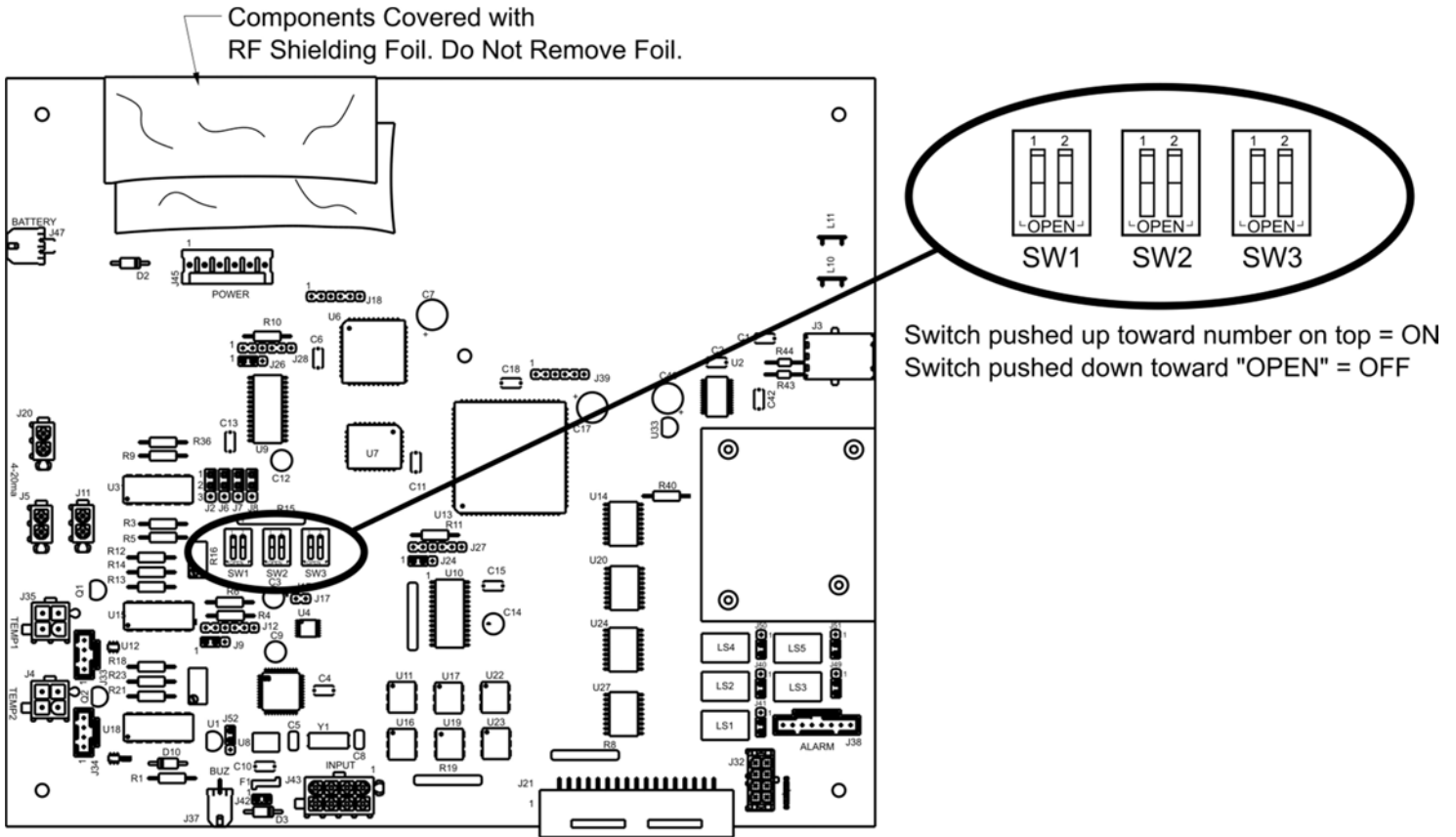

| DIP SWITCH | FUNCTION |
|------------|--|
| SW1-1 | unassigned |
| SW1-2 | unassigned |
| SW2-1 | OFF = Keypad Not Locked ON = Keypad Locked |
| SW2-2 | unassigned |
| SW3-1 | OFF = 5 Independent Alarms ON = 1 Master Alarm |
| SW3-2 | OFF = Alarm Will Not Sound ON = Alarm Will Sound |

Table 3

SW2-1 – Keypad Lockout

Factory default is OFF (open) = keypad not locked.

This security feature prevents unwanted keypad actions. When SW2-1 is turned ON (closed), the system will begin a five (5) minute timer. If there is no pushbutton activity during that length of time, the CryoWiz™ will lockout the front panel pushbuttons. To re-enable the pushbuttons, hold the SOURCE key for approximately 4 seconds. If there is no pushbutton activity for another 5 minutes, the keypad lockout function will resume.

Keypad lockout may also be temporarily disabled using the web server or the service software.

To permanently keep the front panel pushbuttons enabled, SW2-1 must be in the OFF (open) position.

SW3-1 – Alarm Configuration

Factory default is OFF (open) = all alarm relays operate independently.

The CryoWiz has five (5) dry contact alarm relays. Each one is defined in Table 4. There may be applications that require a single relay contact closure, regardless of the alarm event, to be routed to the facility's management system. Turning SW3-1 ON (closed) directs the CryoWiz™ to use the LS1 relay as a master alarm that signals when any of the 5 relays are in the alarm condition.

SW3-2 – Audible Alarm ON/OFF

Factory default is ON (closed) = the audible alarm will sound.

To disable the audible alarm, turn SW3-2 OFF (open).

NOTE:

With the exception of SW3-2, the CryoWiz™ will need to be power cycled for a DIP Switch change to be recognized.

SETTING REMOTE ALARM OUTPUTS

The CryoWiz™ is designed to interface with an external alarm system. Relay contacts are brought out through the 8-pin circular connector on the left side of the cabinet. The pin connections on this connector are set to connect directly to a CONCOA alarm (see section “Connecting a Remote Alarm”). With jumpers in the default position, the contacts are Normally Open (N.O.). In an alarm condition or loss of power, these contacts will open. It is possible to change the jumpers to Normally Closed (N.C.). The figure below shows the location of the jumpers on the lower right side of the main circuit board. There are five jumpers; one for each alarm relay as shown in Table 4. To change a contact from N.O. to N.C., follow the steps below and see table 4:

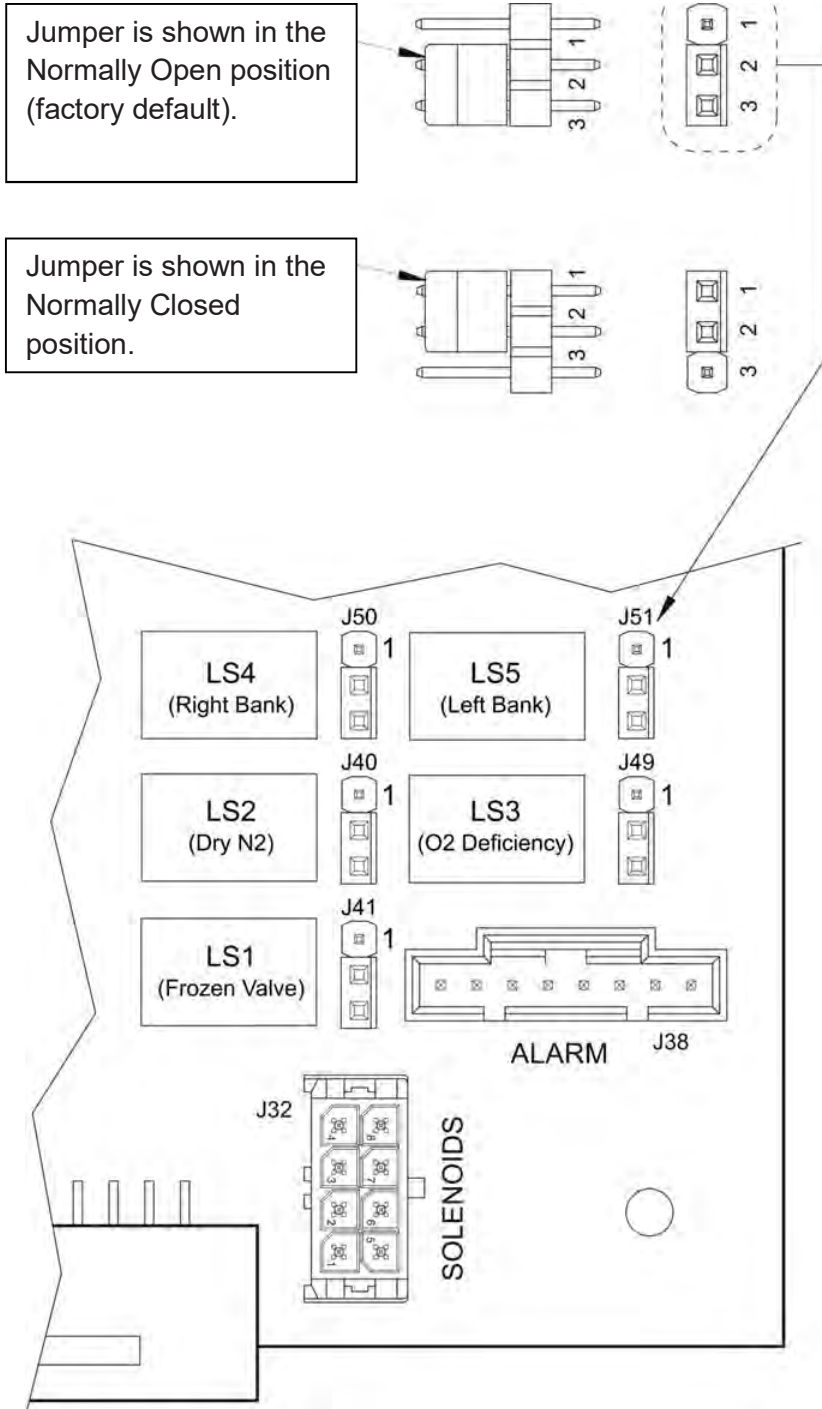

| Relay | JUMPER | FUNCTION |
|-------|--------|---------------------|
| LS1 | J41 | Frozen Valve Alarm |
| LS2 | J40 | Dry N2 Pressure Low |
| LS3 | J49 | Oxygen Deficiency |
| LS4 | J50 | Right Bank Depleted |
| LS5 | J51 | Left Bank Depleted |

Table 4

1. Turn OFF AC power to the system.
2. Open front door by loosening the 4 screws on the front cover.
3. Locate the jumpers on the circuit board.
4. Using table 4 and the figure, set the jumpers.
5. Close door and re-secure it to the cabinet.
6. Make the necessary connections to the alarm, and plug the alarm cable into the alarm connector on the side of the cabinet.
7. Turn AC power ON.

INSTALLING REAL TIME CLOCK BACKUP BATTERIES

The CryoWiz™ keeps an event log that uses a real time clock on the circuit board for a date and time stamp on logged data. It also uses this clock for timed events. The real time clock is backed-up in the event of a power failure by (3) AA batteries installed in the battery pack located inside the CryoWiz™ on the back of the front cover. After installing the CryoWiz™ on the wall with all inlet and outlet connections made and prior to putting any power to the unit, insert the three included AA batteries into the battery pack (see figure below). The batteries typically provide a minimum of 7 days battery backup. It is suggested that the installer write the date the batteries were installed on the label covering the battery pack. The batteries must be replaced annually, or if the power has gone out for more than 24 hours.

To install or change batteries, follow these steps:

1. Make sure that AC power is not connected to the unit.
2. Open the front door by loosening the four screws on the front cover.
3. Locate the battery pack compartment on the back of the front cover – see figure.
4. Install the three AA batteries properly in the battery pack.
5. Close the door, and tighten the 4 screws on the front of the cabinet.
6. Connect AC power.
7. Use the Web Server's CHANGE SETTINGS tab to update the system date and time.

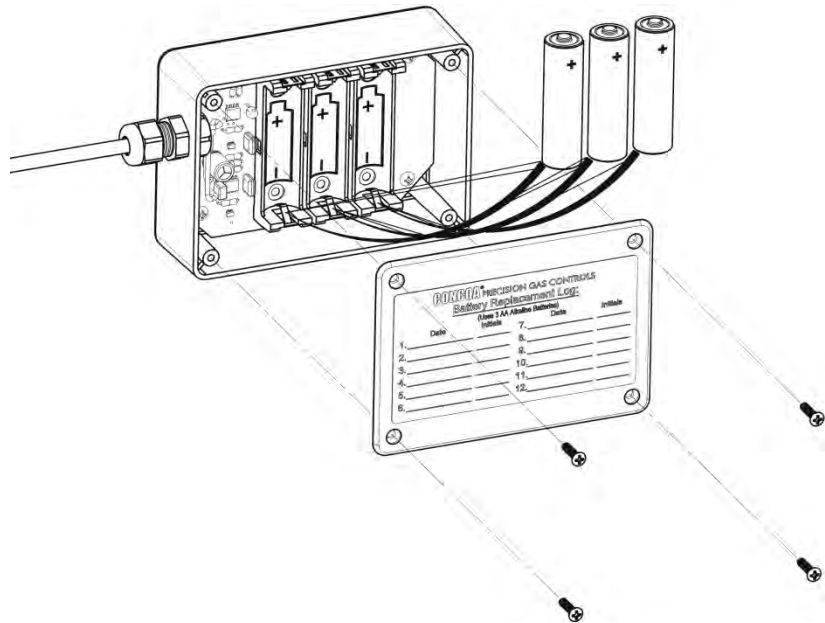

CONNECTING POWER

The CryoWiz™ is supplied with a universal power supply that includes a variety of snap-in international plugs and works with 90 – 264 VAC. The output is 12 VDC, 1.50 amps, 18 watts max. It is strongly recommended that a battery backup such as a UPS be used to ensure the continuous function of the device.

CRYOWIZ™ STARTUP

The initial startup of the CryoWiz™ should always be performed by a CONCOA factory-trained service technician with the area oxygen deficiency monitors functional and enabled. Use proper safety equipment including but not limited to full face shields and cryogenic gloves and aprons as certain steps do require that LN2 be introduced into the system. Proper safety procedures must be maintained at all times when handling LN2.

Once all mechanical connections are made, both on the CryoWiz™ and on any downstream equipment, then pressurize the system and check for leaks.

Ensure that as described in the “Installing the CryoWiz™” section that the system has been connected to a 100 to 110 PSIG pneumatic dry nitrogen supply.

All connections downstream of the system must be connected prior to connecting electrical power and starting up the system. Test for leaks with an appropriate liquid leak test solution. If leaks are discovered, remake connections and recheck.

The CryoWiz™ will start up in the ON DEMAND mode with the left side selected as primary. If desired, use the SOURCE select pushbutton to switch sides. The primary source valve will open and fill the downstream outlet until pressure has equalized. Check for leaks downstream with an appropriate liquid leak test solution. If the system continues to fill with no real demand for liquid downstream, this is an indication of a leak. Turn off power to the unit, and check all connections.

Normal operation of the CryoWiz™ can now begin. All switching is automatic.

OPERATING THE CRYOWIZ

The front display of the CryoWiz™ shows the system's status and provides (6) pushbuttons for performing the normal operating functions of the unit.

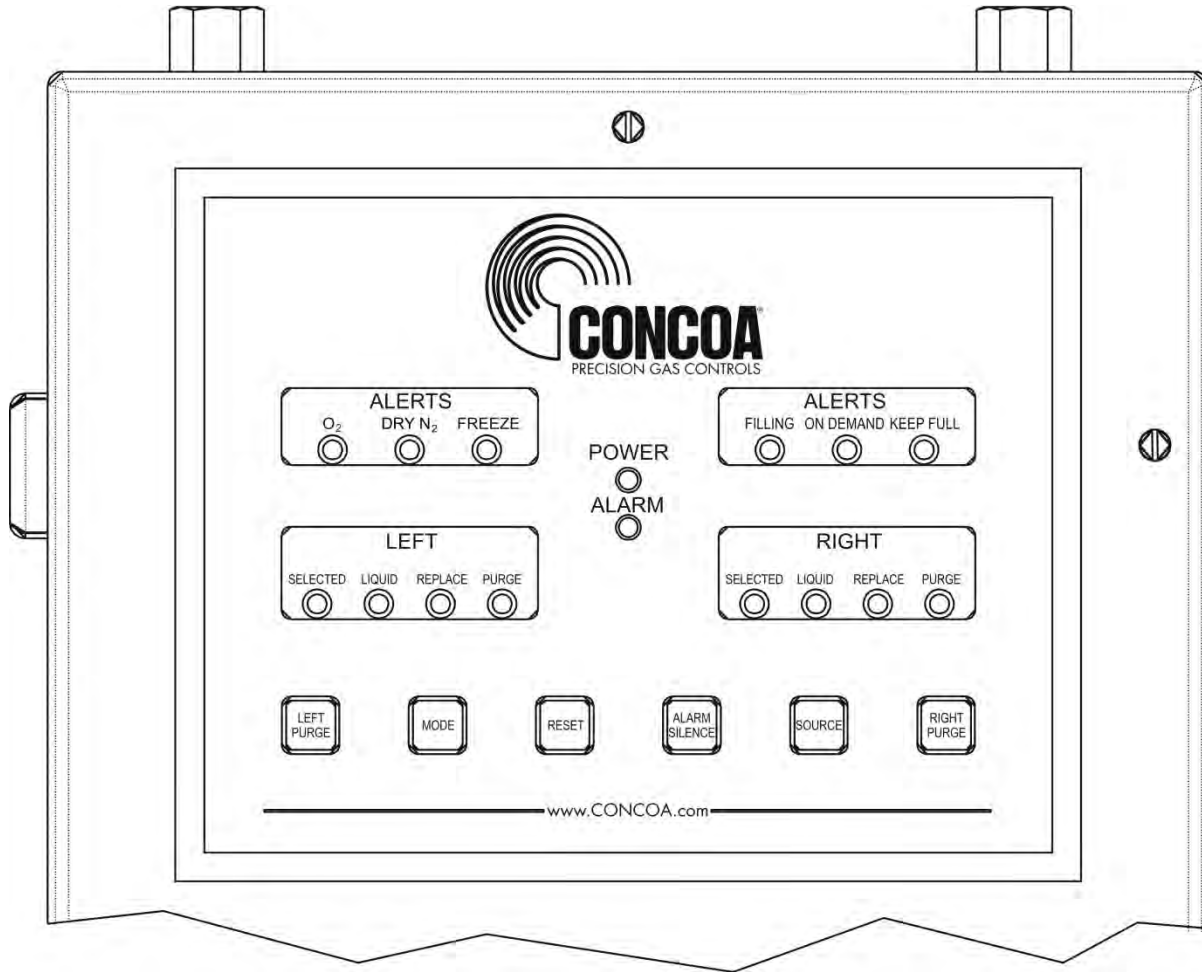

Source Selection

The SOURCE button on the front panel allows for manual switching of the active bank. The SELECTED status indicator lights provide feedback to indicate which side is chosen. Select which side you wish to operate initially by using the SOURCE button.

Mode Selection

The MODE button allows you to change mode of operation. The system will initially start up in the ON DEMAND mode. To change to KEEP FULL mode, press the MODE button once. Make sure your mode of operation is suitable for your system's demand and sources.

Reset

The RESET button is primarily used to reset the system after a depleted bank has been replenished following illumination of the REPLACE warning light. The REPLACE status light can only be cleared if the side with the REPLACE condition has its pressure restored to a value above the trip point.

The RESET button must also be pressed to clear any alarm condition. Ensure that the cause of the alarm condition has been rectified before pressing RESET.

Purging

During normal operation, any necessary purging is done automatically. If desired, you can manually purge either side by pushing and holding the LEFT PURGE or RIGHT PURGE button. The left and right banks each have a dedicated LIQUID light. When the light is yellow, the unit has determined that the supply source is not in need of replenishment; however it does need to purge a buildup of gaseous nitrogen. Once the CryoWiz™ detects liquid at the source valve, the light will change to green.

Alarm Conditions

There are five possible alarm conditions that the CryoWiz™ can display and relay to a remote alarm:

1. O₂: This alarm indicates that an oxygen deficiency monitor has relayed an alarm condition to the system, and that the CryoWiz™ has shut off all valves. A red light in the ALERTS section of the front graphic illuminates for this condition.
2. DRY N₂: This alarm indicates that the pneumatic dry nitrogen inlet pressure has dropped below the pressure required to operate the system (90 psig). A red light in the ALERTS section of the front graphic illuminates for this condition.
3. FREEZE: This alarm indicates that the system has sensed that a valve may be in a frozen condition. A red light in the ALERTS section of the front graphic illuminates for this condition.
4. REPLACE (left): This alarm indicates that the left bank has been depleted. A red light in the LEFT section of the front graphic illuminates for this condition.
5. REPLACE (right): This alarm indicates that the right bank has been depleted. A red light in the RIGHT section of the front graphic illuminates for this condition.

Oxygen Deficiency Alarm Condition

Due to the possibility of an oxygen deficient atmosphere when dealing with LN₂, the CryoWiz™ has been designed to integrate with oxygen deficiency monitors (see section “Connecting and Oxygen Deficiency Monitor”). If an oxygen deficiency monitor has an alarm condition and a compatible output, the alarm can be relayed to the CryoWiz™. The CryoWiz™ will immediately close™ all valves, illuminate the red O₂ alarm light, and sound the audible alarm if it is enabled. The unit will go back to normal operation only when the source of the alarm has been cleared.

If an oxygen deficiency monitor is alarming, do not enter the space where oxygen deficiency has been detected. If the LN₂ cylinders are located outside the oxygen-deficient space, close the cylinder valves, and notify appropriate safety personnel. The oxygen deficient area must be appropriately ventilated until the source of the oxygen deficiency has been determined and corrected.

Turn the LN₂ cylinder valves back on only after the alarm condition has been corrected.

Freeze Alarm Condition

This alarm indicates that one of the valves on the CryoWiz™ has frozen shut. This is an extremely rare event. No occurrence has ever been recorded. If the system detects that a valve has frozen shut, turn off the LN₂ supply, and allow sufficient time for the unit to defrost and warm up. This may take several hours. During this time, ensure that all critical samples and equipment are adequately filled or supplied. Once the system has defrosted, turn the CryoWiz™ and its LN₂ supply back on, and verify that the freeze alarm has cleared. If not, contact CONCOA or your local CONCOA service center.

Dry Nitrogen Alarm Condition

The DRY N₂ alarm indicates that the pneumatic dry nitrogen gas supply has dropped below the alarm set point and may not be able to keep the system running properly. Check to make sure that the pneumatic dry nitrogen supply is between 100 and 110 psig.

Replace Alarm Condition

The system has determined that a bank is now empty. The corresponding bank REPLACE light will illuminate red, and the audible alarm will sound. Once the empty side is replenished with cylinders supplying the CryoWiz™ with sufficient LN₂ pressure, press the RESET button to extinguish the alarm.

Alarm Silence

The alarm silence button will silence the local audible alarm. The alarm indicator light will remain illuminated until the alarm condition has been cleared.

COMMUNICATION MODE

The CryoWiz™ has the built in capability to communicate externally via the Ethernet (Web Server) or USB port.

The USB port is to be used only by Factory Authorized Technicians to customize the setup of the CryoWiz™.

The Ethernet port (Web Server) is used for all end user remote communication. This includes email notification, system status viewing, and event logging.

CONNECTING THE WEB SERVER

The CryoWiz™ has an integral Web Server device. Connection to the Web Server is through an RJ45 Ethernet connector located on the left side of the CryoWiz™. Unscrew the protective cap that covers the connector jack to insert the Ethernet cable. Use any CAT 5 or CAT 6 cable to make this connection to the local area network. Refer to the Web Server ADI included with the CryoWiz™ for instructions on interfacing it to the local area network (CONCOA instruction manual 99065774 [ADI5774]).

POWER REQUIREMENTS

Input Voltage: 90 - 264 VAC, 50 / 60hz

Power Consumption: 20 watts

Date and Time Event Clock: 3 AA batteries.

SERVICE

For Service to the CryoWiz™, contact your local Distributor or CONCOA Customer Service at 1-800-225-0473.

FACTORY DEFAULT SETTINGS

Communication: USB, Ethernet (Web Server)

Units of Measure: °C, psig

Keypad Lockout Security: Disabled

Alarm Configuration: 5 Independent Alarm Relays
(Left Bank Depleted, Right Bank Depleted, Dry N2 Supply Pressure Low,
Oxygen Deficiency, Frozen Valve Alarm)

Audible Alarm: Enabled

Liquid Nitrogen Reference Data

Liquid nitrogen has a textbook boiling point of -196°C. The CryoWiz operates on 35 PSIG max inlet pressure with a 50 PSIG relief valve. Expected liquid nitrogen temperatures are based on the respective pressures per the table below:

| Nitrogen Boiling Curve | | CryoWiz +/- 5°C reading | | |
|------------------------|------------------------------|----------------------------|--------------------|---------------------------------------|
| Pressure PSIG | Boiling Temperature °C | CryoWiz Low °C | CryoWiz High °C | |
| 50 | -181 | -186 | -176 | <- Max Pressure / Temp (Relief Valve) |
| 45 | -182 | -187 | -177 | |
| 40 | -183 | -188 | -178 | <- Max Inlet Pressure / Temp (Rated) |
| 35 | -184 | -189 | -179 | |
| 30 | -185 | -190 | -180 | |
| 25 | -186 | -191 | -181 | |
| 20 | -188 | -193 | -183 | |
| 15 | -189 | -194 | -184 | |
| 10 | -191 | -196 | -186 | |
| 5 | -193 | -198 | -188 | |
| 0 | -196 | -201 | -191 | |



Controls Corporation of America
1501 Harpers Road
Virginia Beach, Va. 23454

CE DECLARATION OF CONFORMITY
In accordance with ISO/IEC 17050

The 577 Series Cryogenic Switchover is compliant with the CE directives and standards listed below:

Directives:

- Electromagnetic Compatibility (2004/108/EC)
- Low-Voltage (2006/95/EC)
- RoHS (2002/95/EC)

Standards:

- EMC: EN61326-1
- EMC: EN61000-4, EN61000-6
- EMC: CIPSR-11
- Safety: EN 61010-1



QUALITY MANAGER

WARRANTY INFORMATION

This equipment is sold by CONTROLS CORPORATION OF AMERICA under the warranties set forth in the following paragraphs. Such warranties are extended only with respect to the purchase of this equipment directly from CONTROLS CORPORATION OF AMERICA or its Authorized Distributors as new merchandise and are extended to the first Buyer thereof other than for the purpose of resale.

For a period of one (1) year from the date of original delivery (90 days in corrosive service) to Buyer or to Buyer's order, this equipment is warranted to be free from functional defects in materials and workmanship and to conform to the description of this equipment contained in this manual and any accompanying labels and/or inserts, provided that the same is properly operated under conditions of normal use and that regular periodic maintenance and service is performed or replacements made in accordance with the instructions provided. The foregoing warranties shall not apply if the equipment has been repaired: other than by CONTROLS CORPORATION OF AMERICA or a designated service facility in accordance with written instructions provided by CONTROLS CORPORATION OF AMERICA; or altered by anyone other than CONTROLS CORPORATION OF AMERICA; or if the equipment has been operated under improper conditions or outside published specifications; or if the equipment has been damaged or does not function due to improper installation, improper supply of required utilities, accident, abuse, misuse, natural disaster, insufficient or excessive electrical supply, abnormal mechanical or environmental conditions, or debris or particles in the gas or liquid source of supply.

CONTROLS CORPORATION OF AMERICA's sole and exclusive obligation and Buyer's sole and exclusive remedy under the above warranties is limited to repairing using new or reconditioned parts or replacing, free of charge except for labor if permanently installed for the continuous supply of gas by other than a technician certified by CONTROLS CORPORATION OF AMERICA specifically to do so, at CONTROLS CORPORATION OF AMERICA's option, the equipment or part, which is either (1) reported to its Authorized Distributor from whom purchased, and which if so advised, is returned with a statement of the observed deficiency, and proof of purchase of equipment or part not later than seven (7) days after the expiration date of the applicable warranty, to the nearest designated service facility during normal business hours, transportation charges prepaid, and which upon examination, is found not to comply with the above warranties with return trip transportation charges for the equipment or part paid by Buyer or (2) in the case of designated equipment permanently installed for the continuous supply of gas, reported to an Authorized Service Center with proof of initial installation no later than seven (7) days after the expiration date of the applicable warranty, and which is evaluated for compliance with the above warranties by technician certified by CONTROLS CORPORATION OF AMERICA, and which is determined by CONTROLS CORPORATION OF AMERICA based on said evaluation to be non-compliant.

CONTROLS CORPORATION OF AMERICA SHALL NOT BE OTHERWISE LIABLE FOR ANY DAMAGES INCLUDING BUT NOT LIMITED TO: INCIDENTAL DAMAGES, CONSEQUENTIAL DAMAGES, OR SPECIAL DAMAGES, WHETHER SUCH DAMAGES RESULT FROM NEGLIGENCE, BREACH OF WARRANTY OR OTHERWISE.

THERE ARE NO EXPRESS OR IMPLIED WARRANTIES WHICH EXTEND BEYOND THE WARRANTIES HEREINABOVE SET FORTH. CONTROLS CORPORATION OF AMERICA MAKES NO WARRANTY OF MERCHANTABILITY OR FITNESS FOR A PARTICULAR PURPOSE WITH RESPECT TO THE EQUIPMENT OR PARTS THEREOF.

This page intentionally left blank.



Certified ISO 9001:2008

**Controls Corporation of America
1501 Harpers Road • Virginia Beach, VA 23454
Telephone 1-800-225-0473 or 757-422-8330 • Fax 757-422-3125
www.concoa.com**

ADI 5770-Q